

Ponchos, Capes, Coats and
More—Fashionable Warmers
That are Easy to Sew

FULL SIZE PATTERN SHEET

A SIDE

PATTERN 1

A Front and Back, Facing

B Front and Back, Sleeve
Ruffle

C Hood

D Sleeve, Front and Back

E Front and Back

PATTERN 2

H Hood

PATTERN 3

K Faux Collar

PATTERN 5

Q Sleeve

R Sleeve

S Sleeve, Hood

U Sleeve

V Sleeve

- * No seam allowances are printed on the pattern sheets. Please refer to the cutting layout diagrams in the main text and add seam allowances when transferring patterns to paper.
- * Patterns are not given for some ruffles, loops and other pieces. Please refer to the main text for these also and draft the patterns yourself or mark them out directly onto the fabric.
- * Four sizes are given on the pattern sheet unless otherwise specified (7, 9, 11, 13). Please use the chart on page 29 of the book when selecting your size.
- * Please note that depending on the type of paper and tracing tools used, there may be slight variations in measurements.

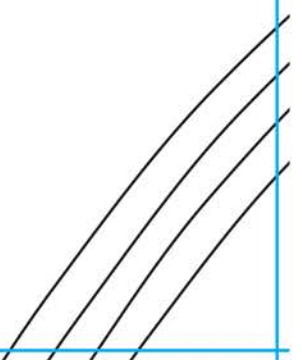

Stylish Wraps

© 2011 Yoshiko Tsukiori
Bunka Puushing Bureau

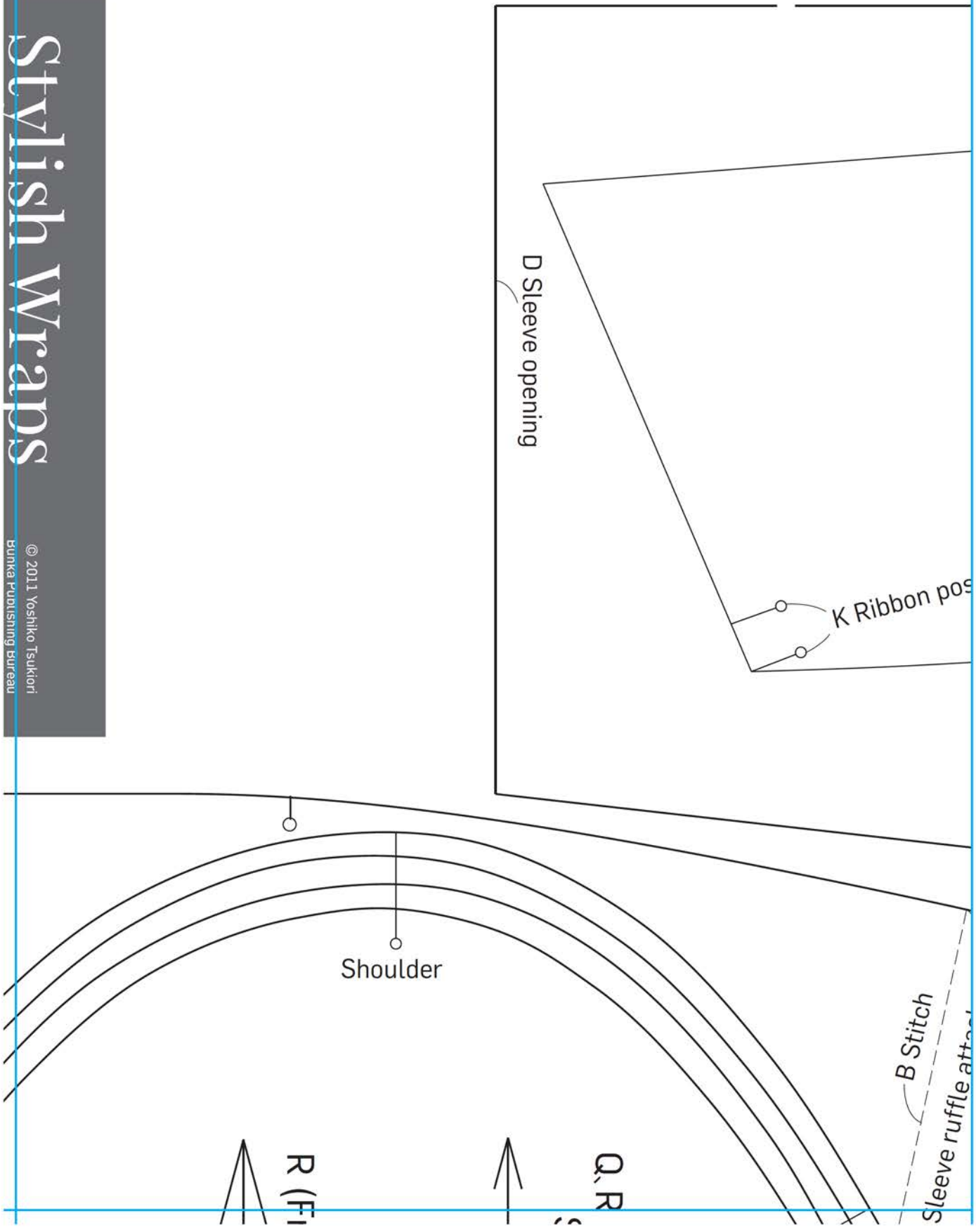

A3

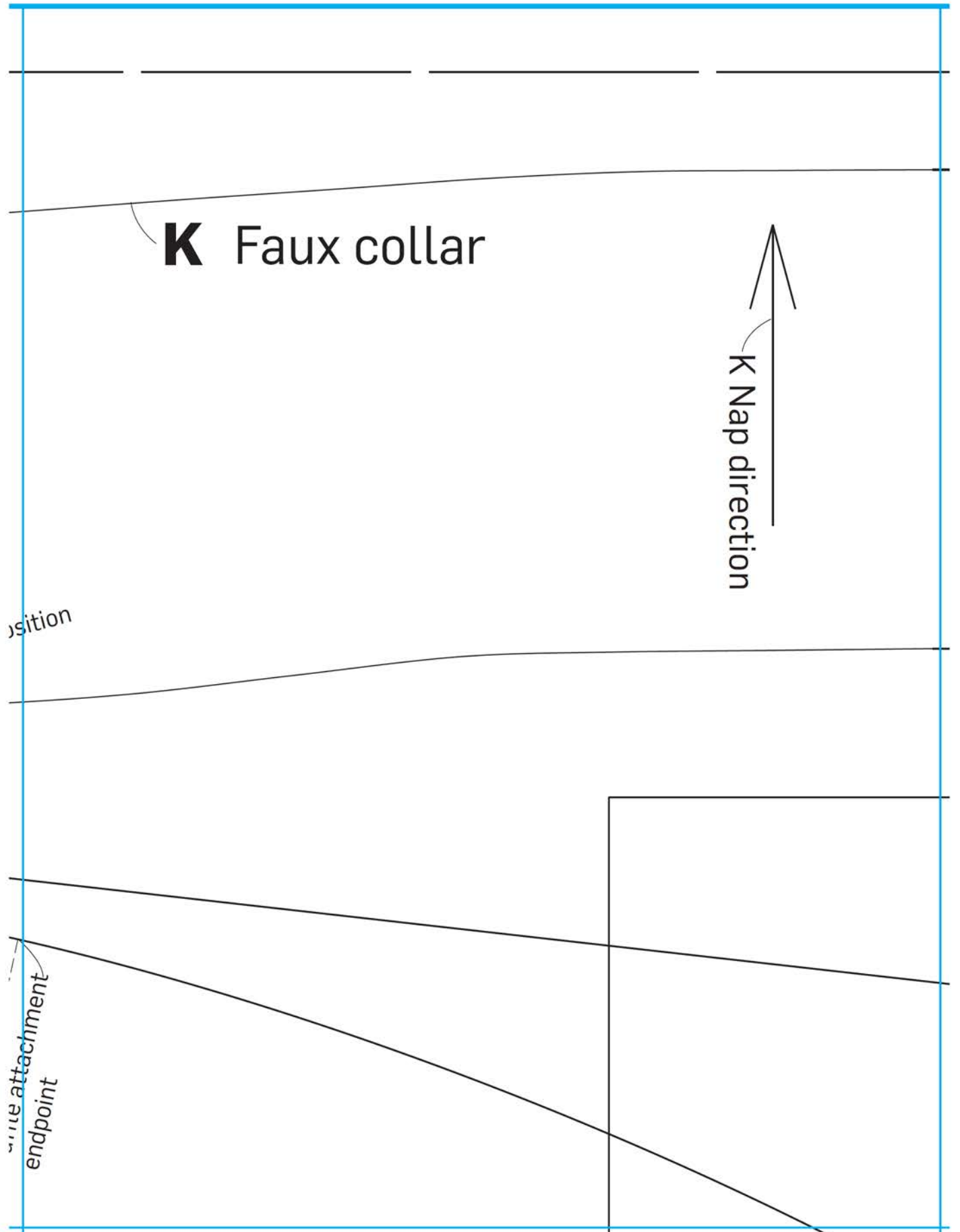

A4

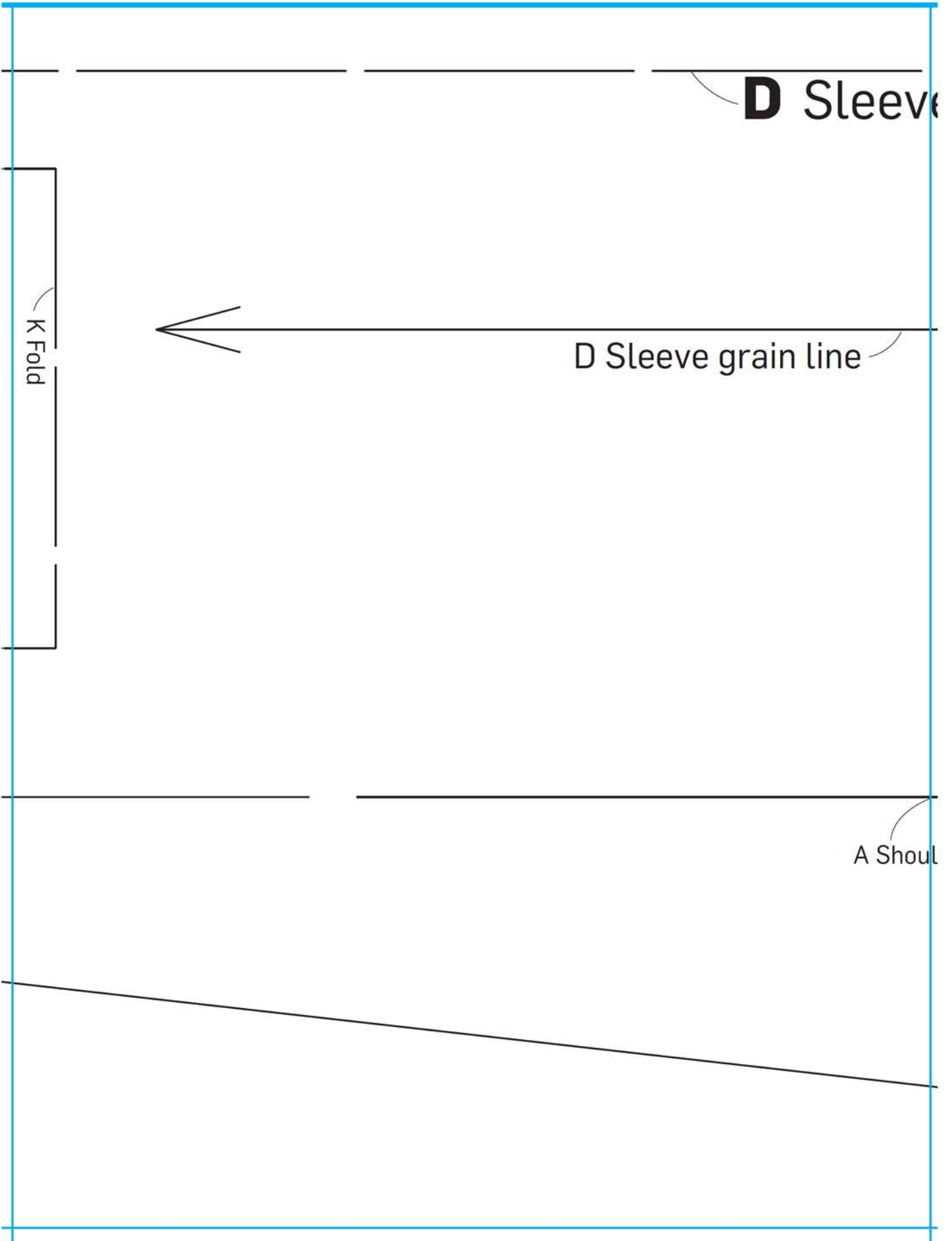

A5

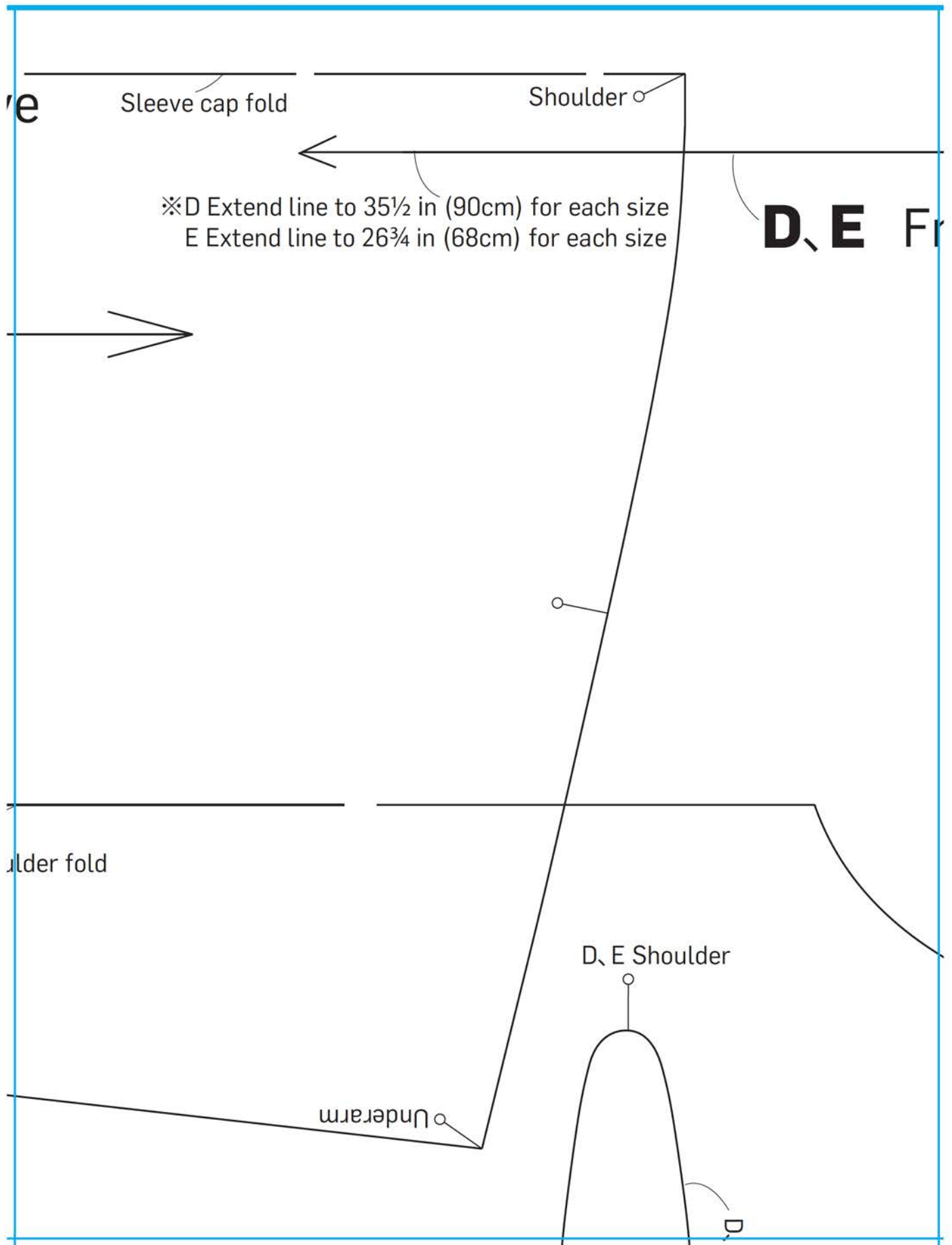

A6

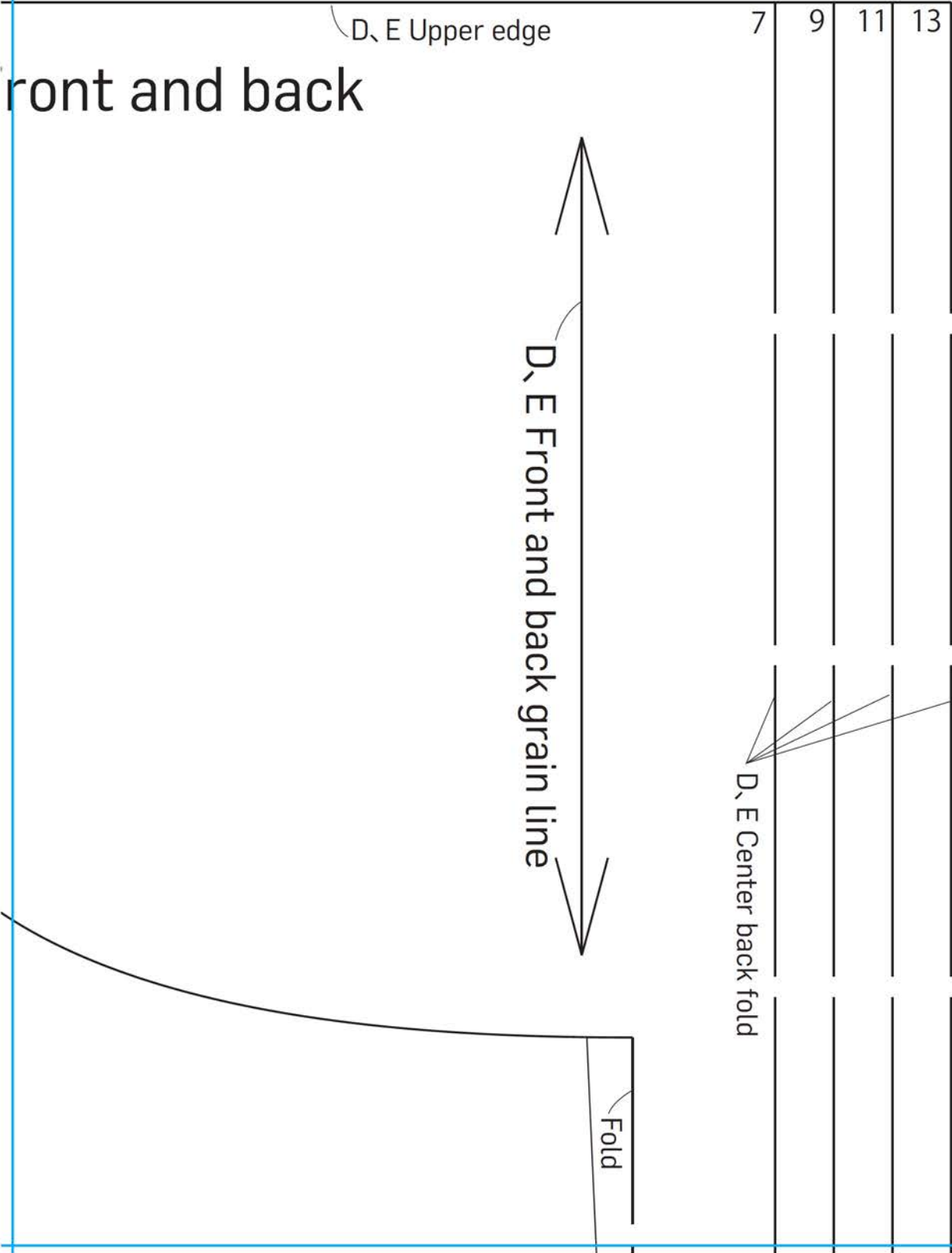

B1

Q, R, S, U, V
Sleeve

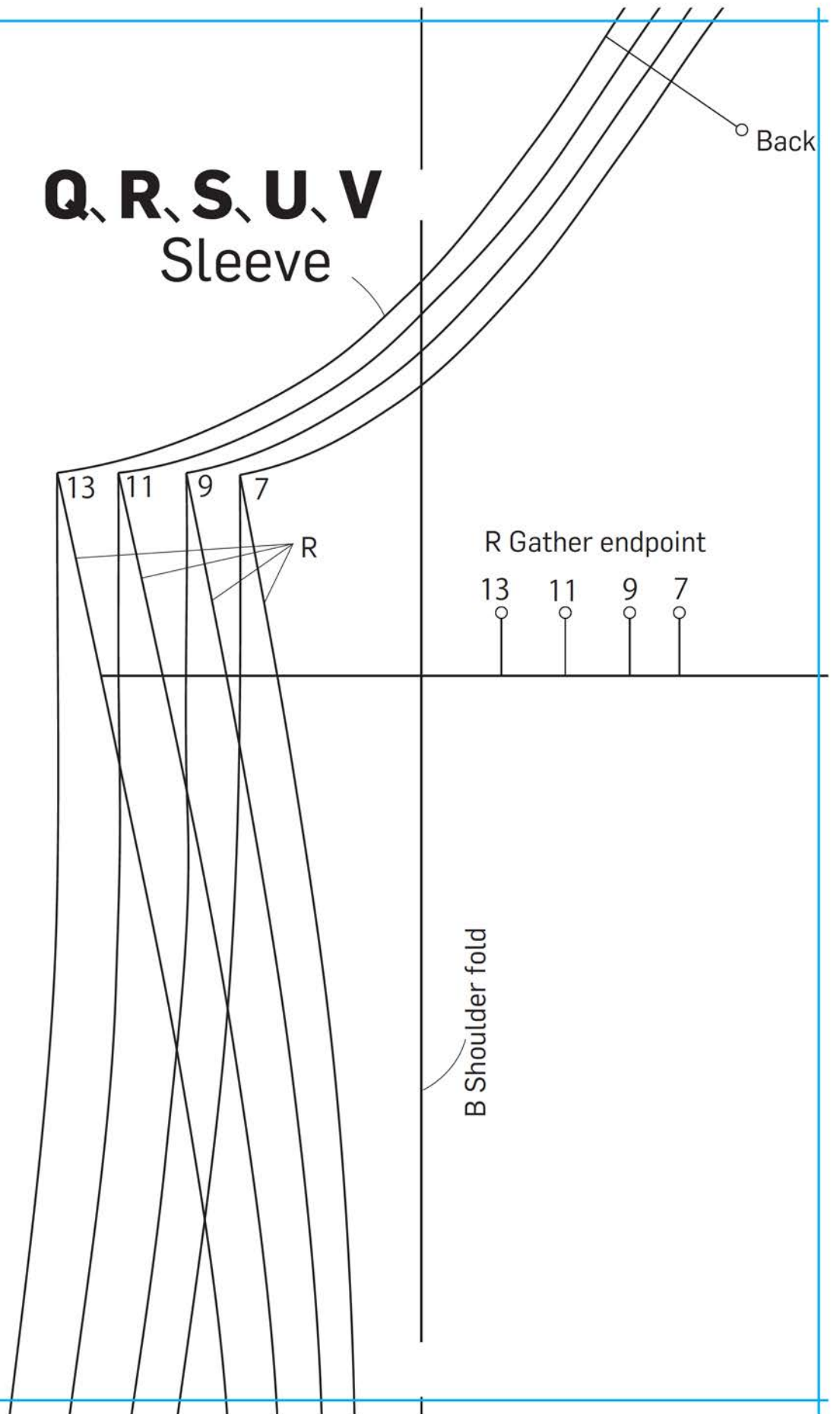

B2

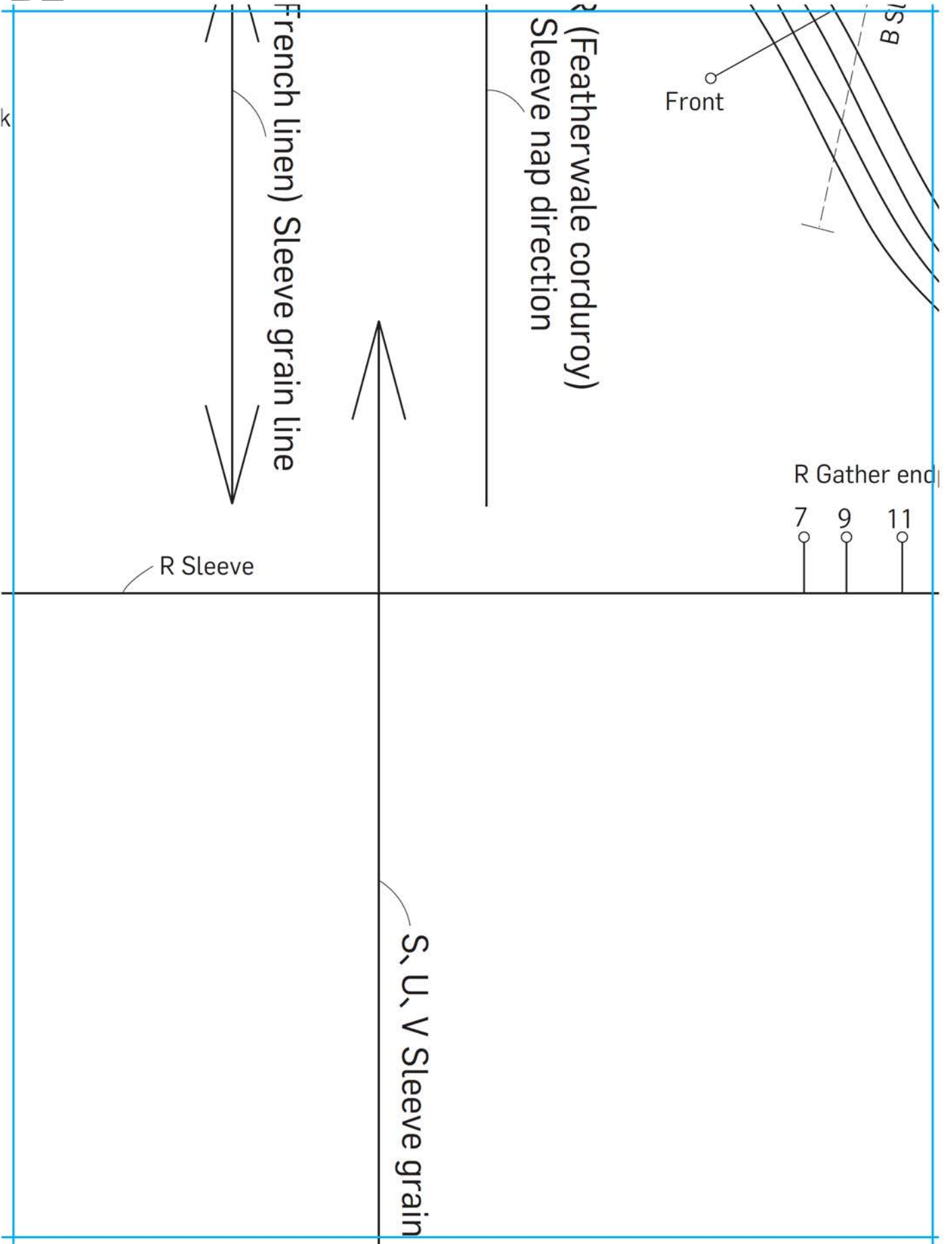

B3

B Sleeve

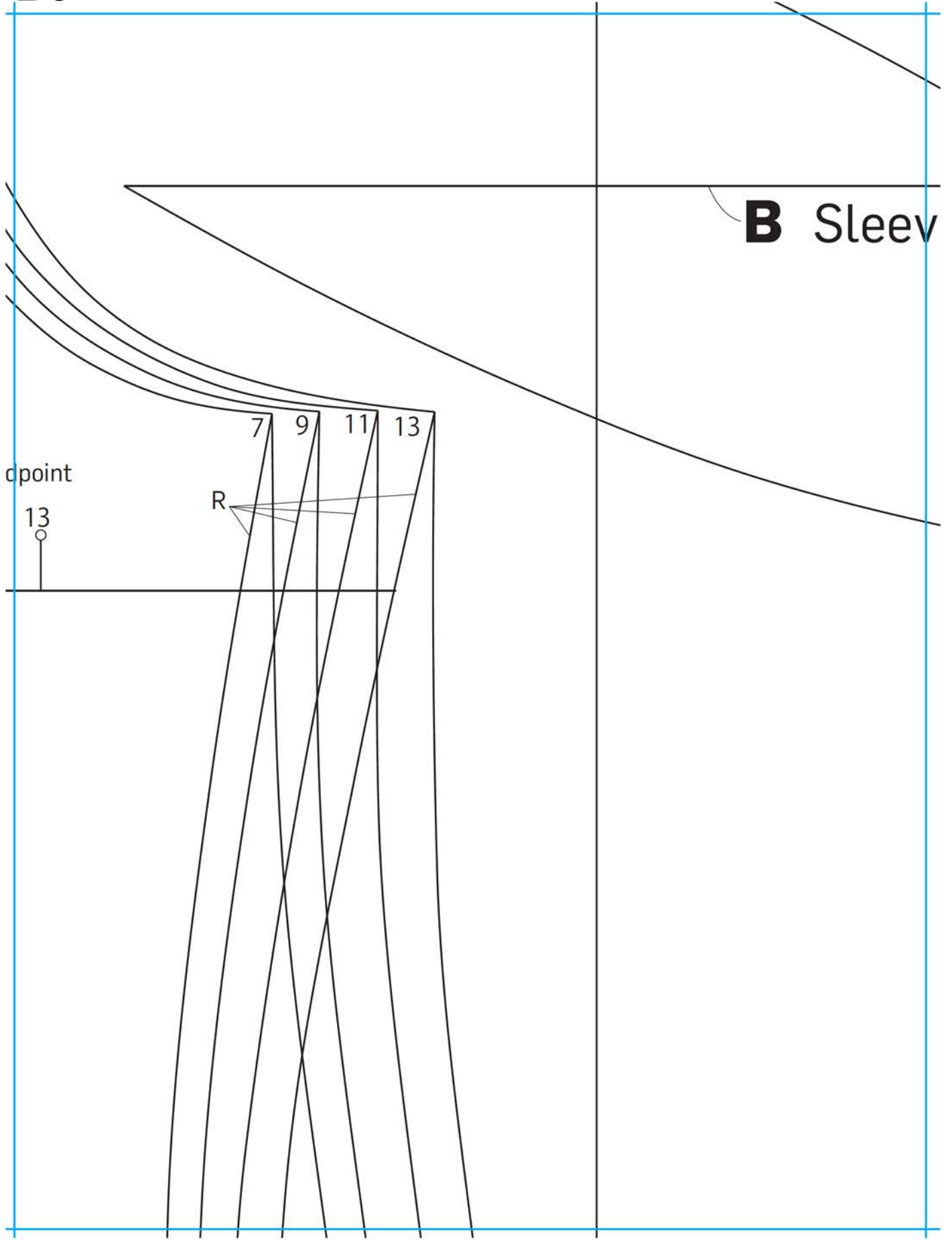

B4

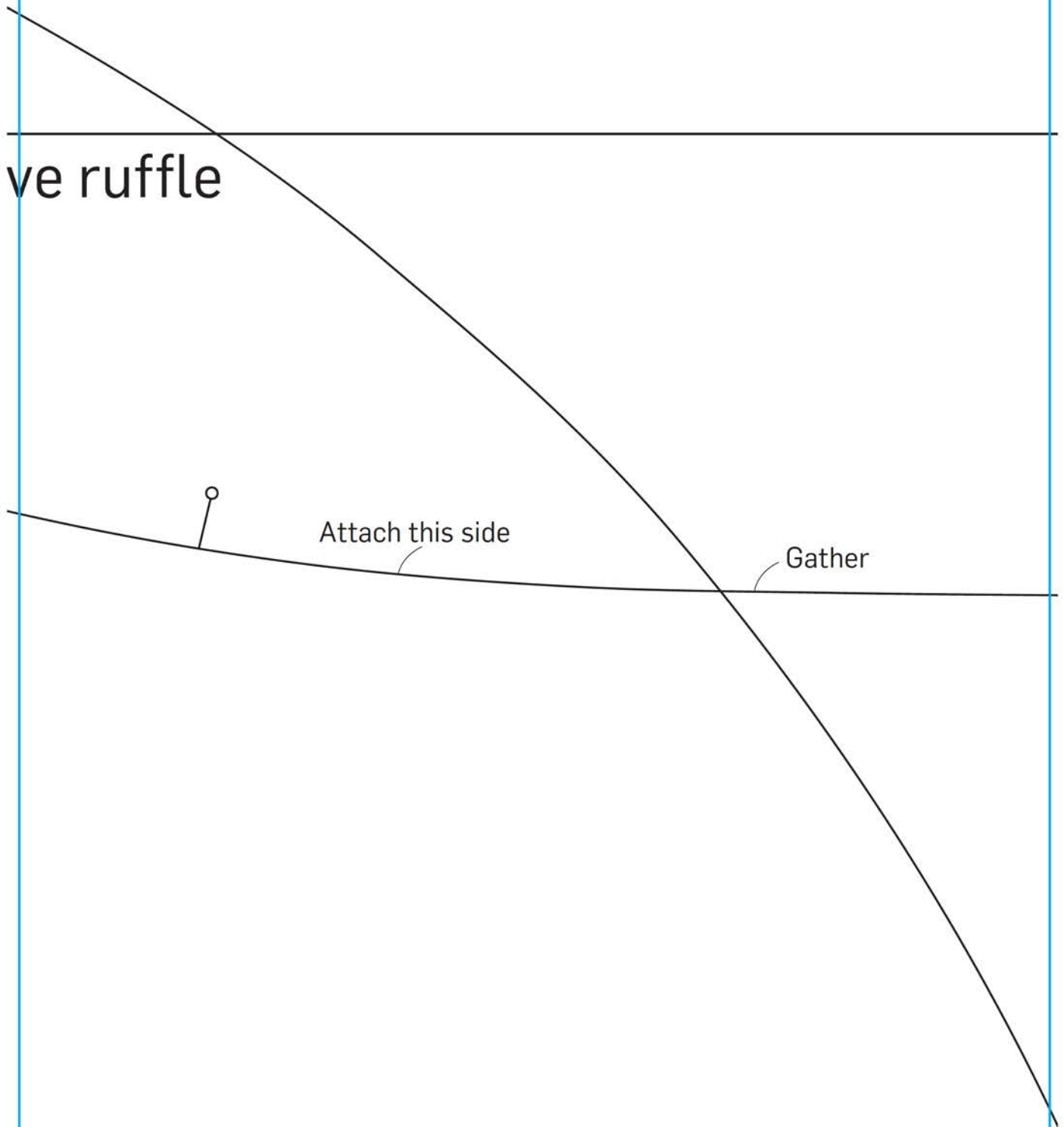

13	11	9	7
----	----	---	---

B5

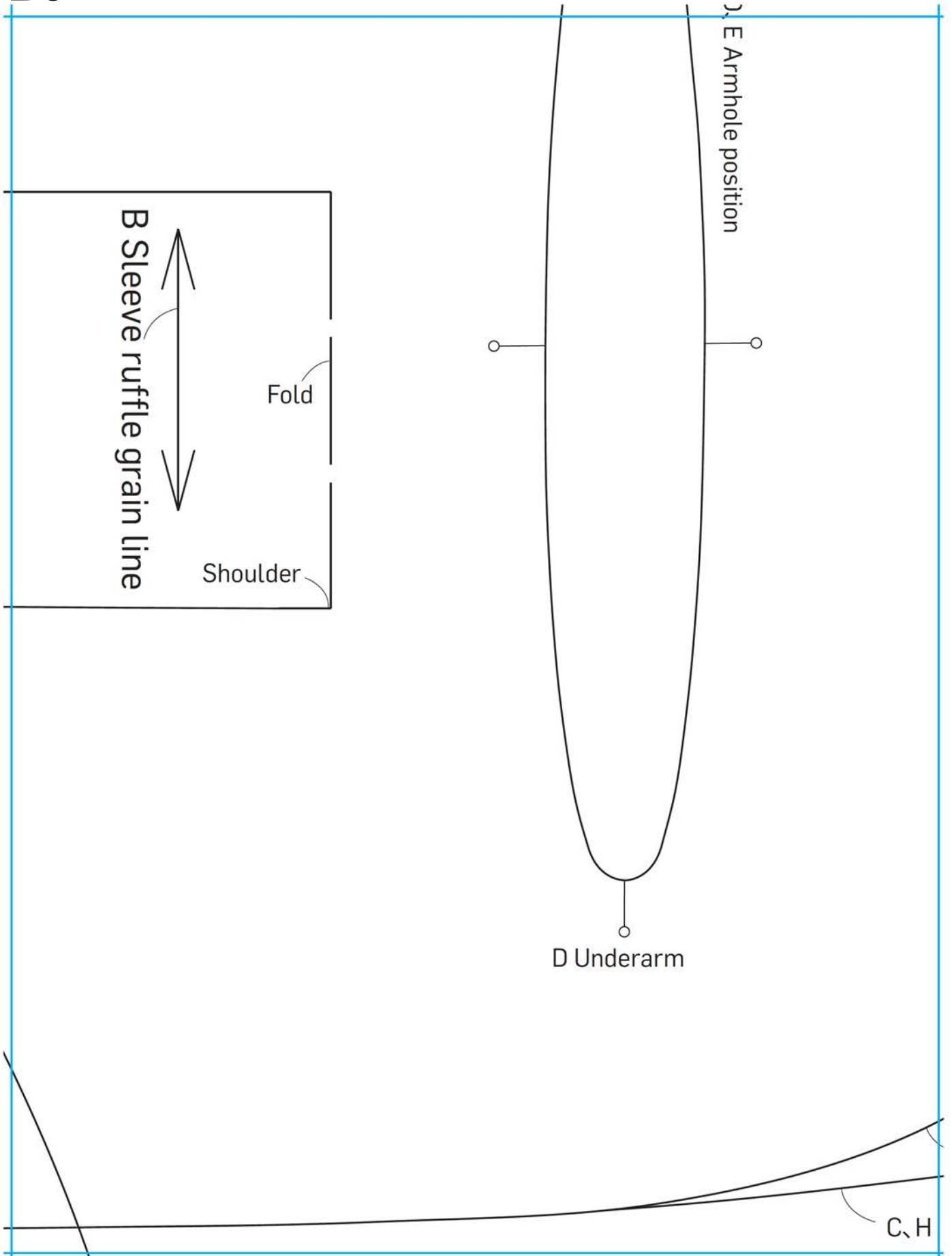

B6

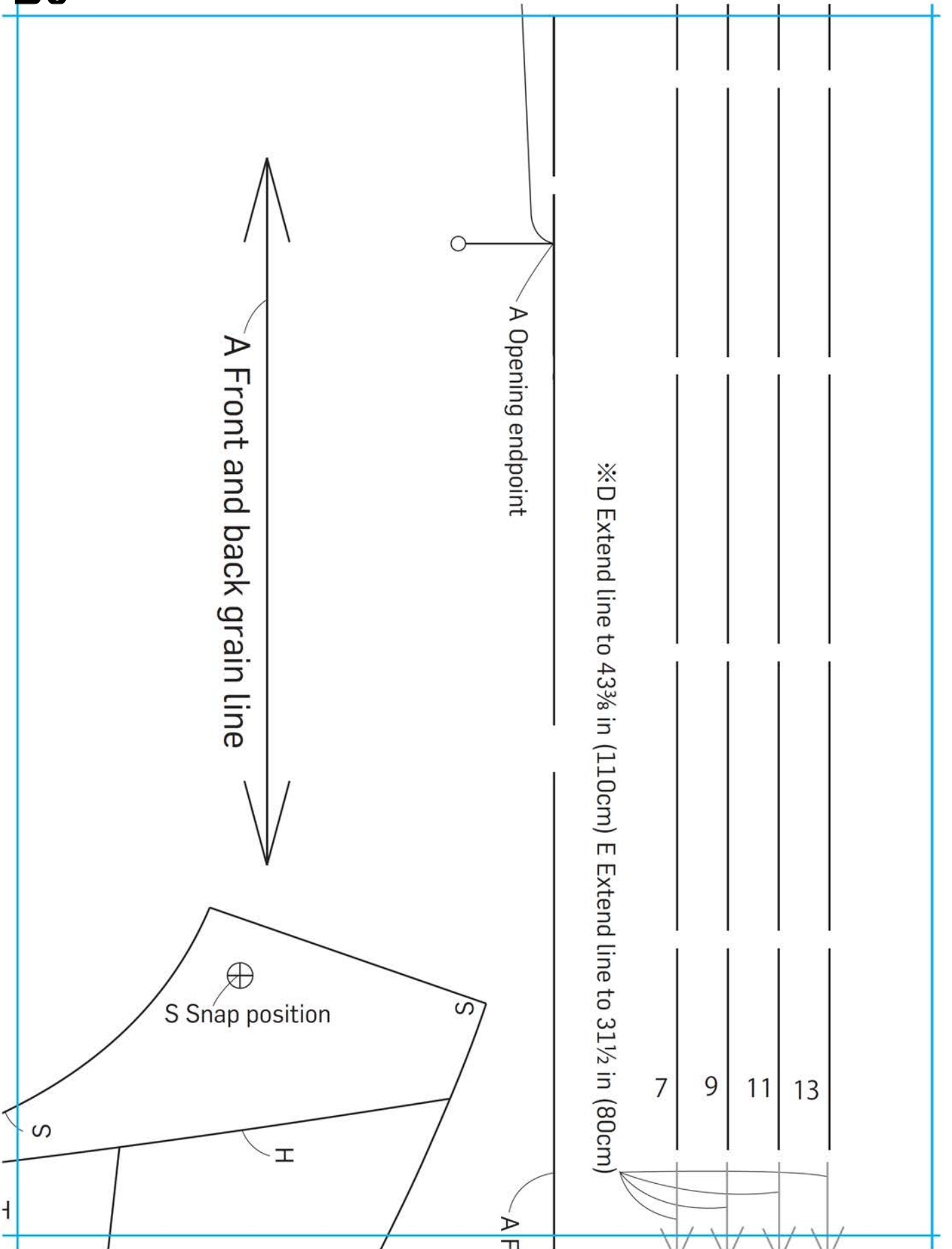

C1

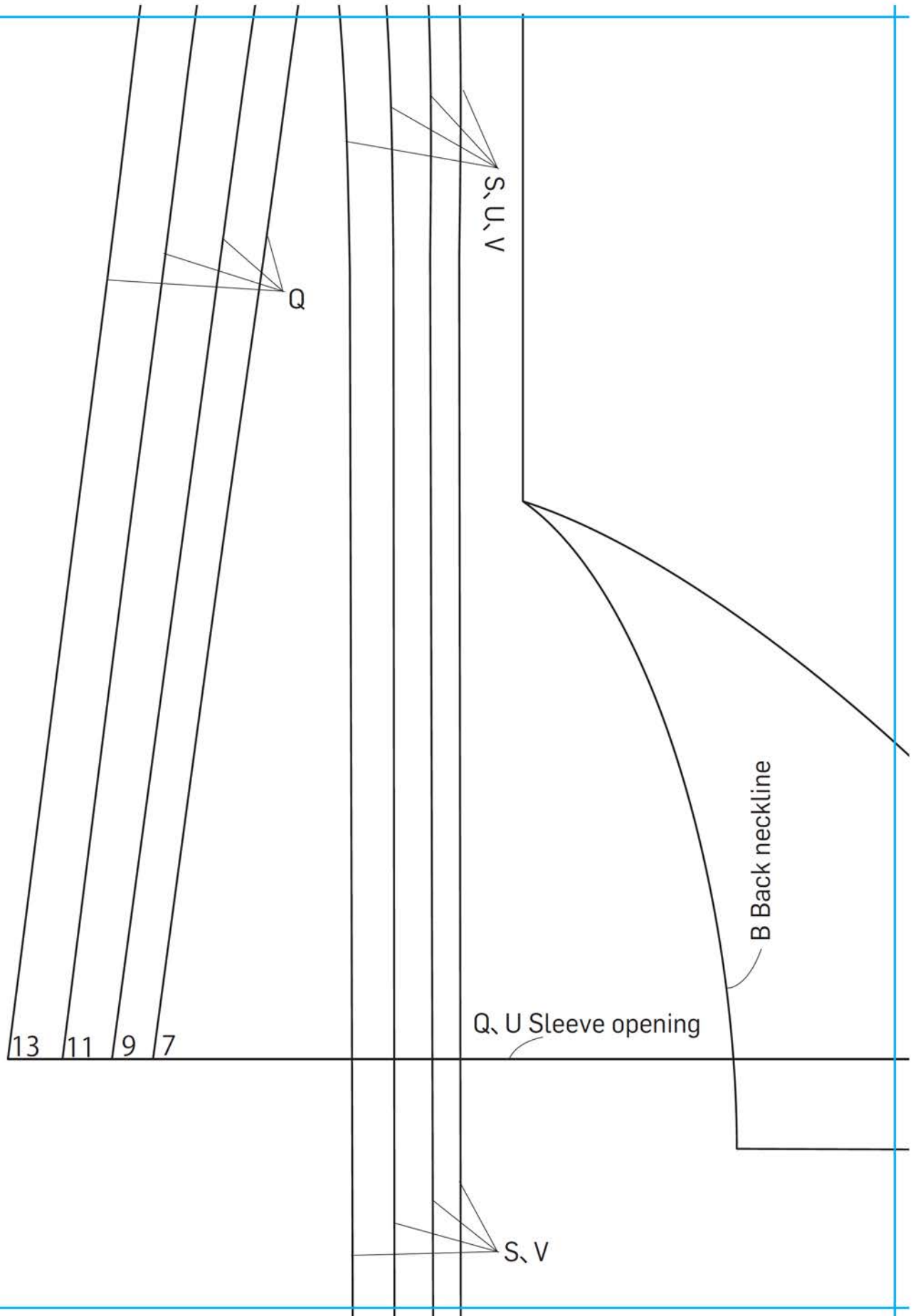

C2

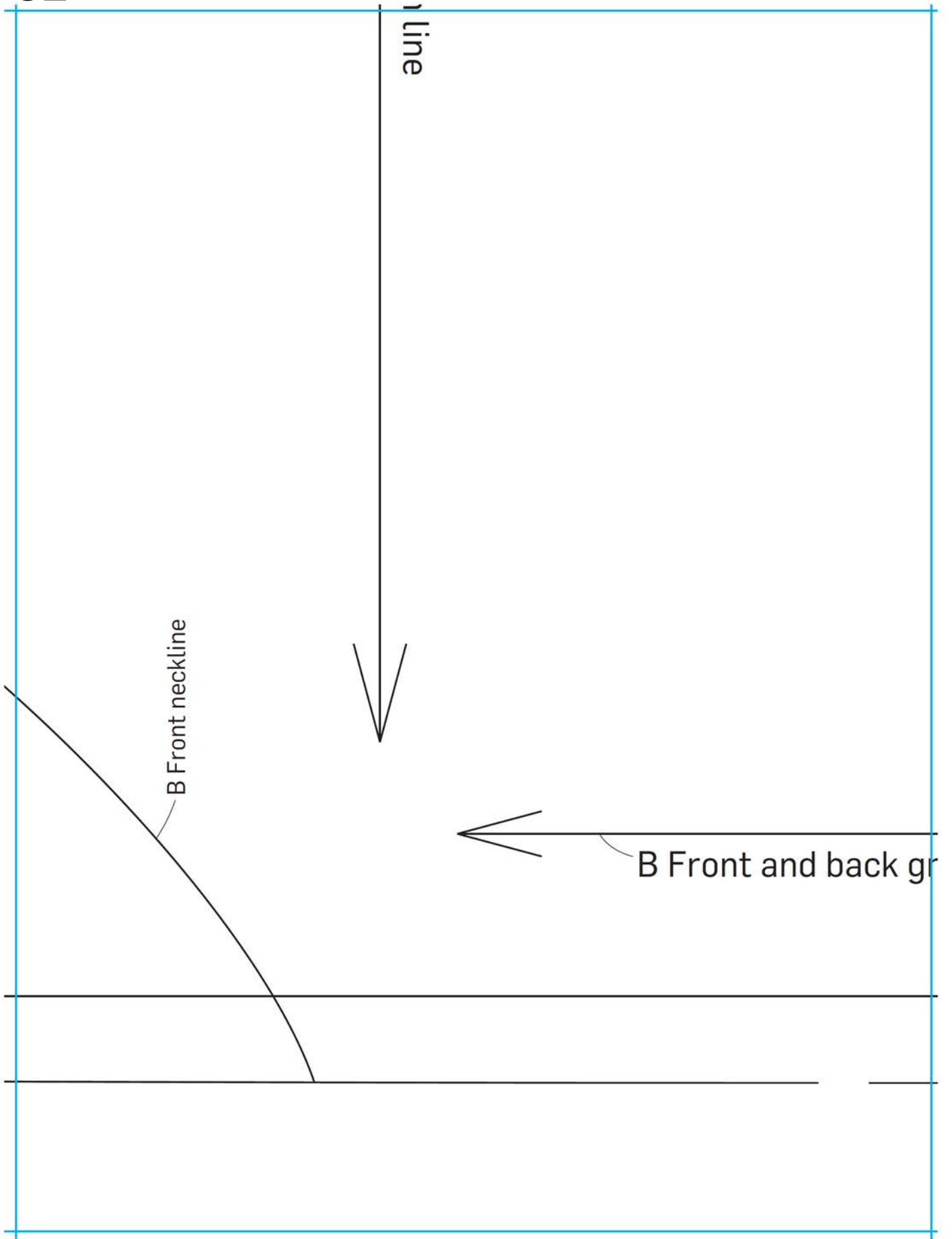

C3

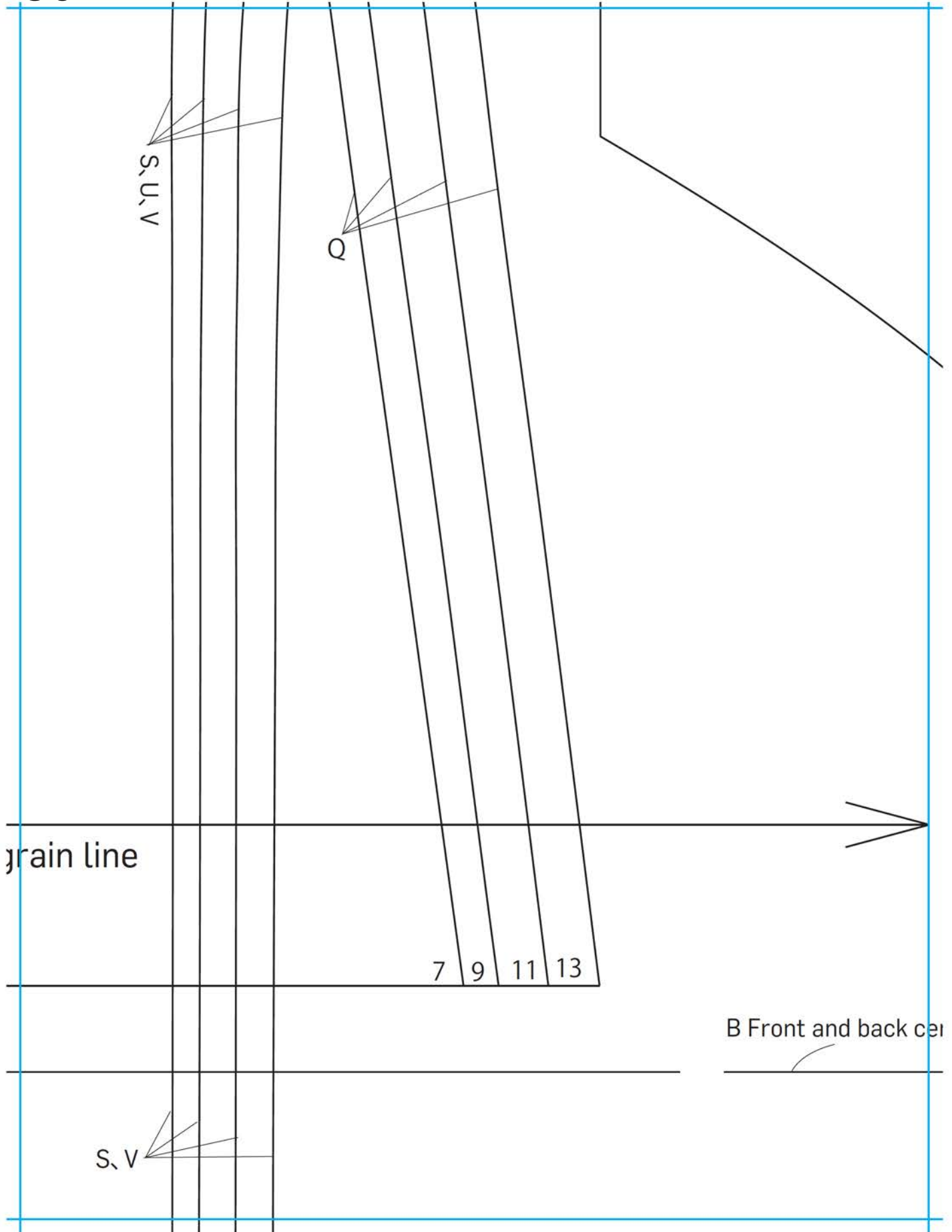

C4

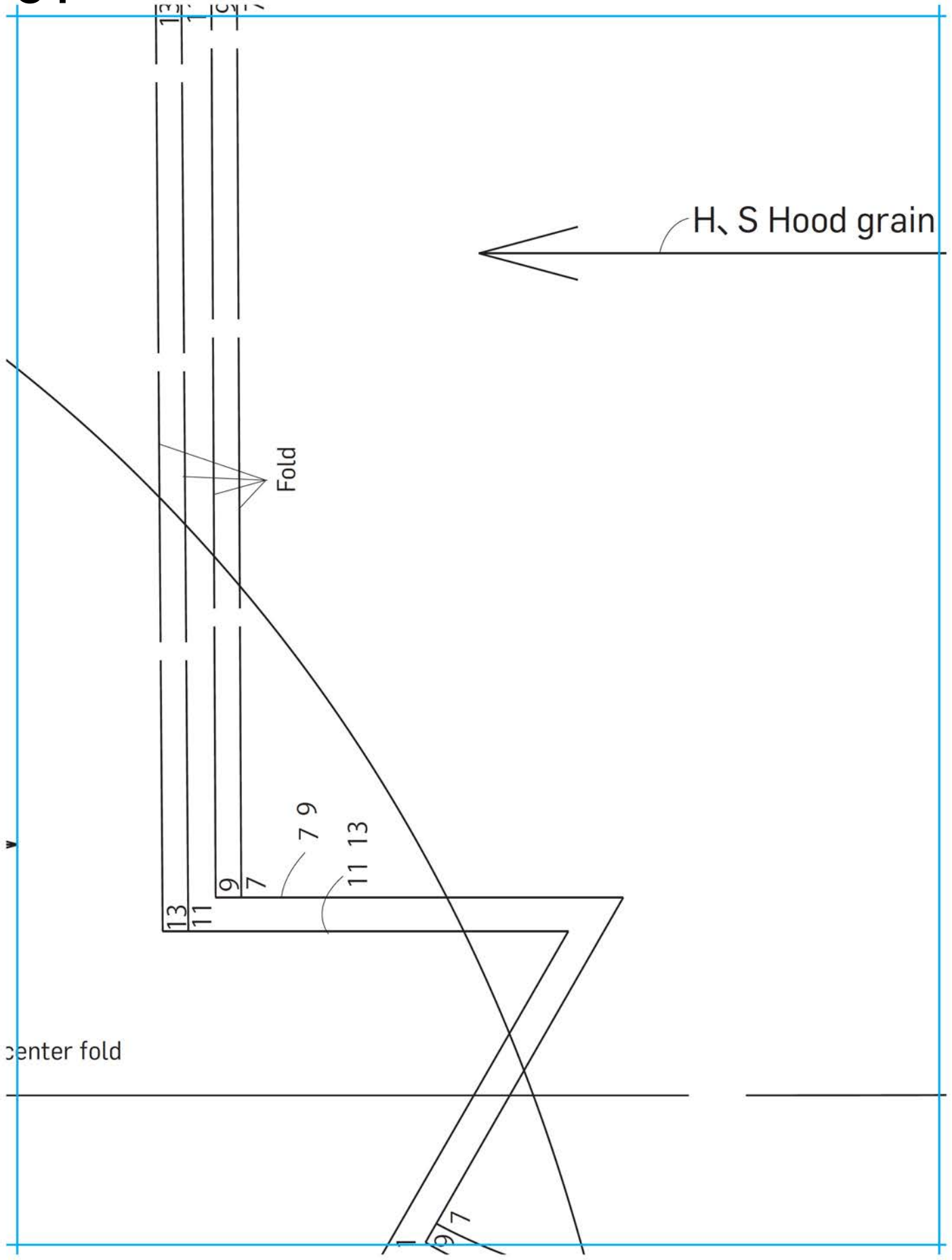

C5

1 line

B Front and back

C Hood grain line

c

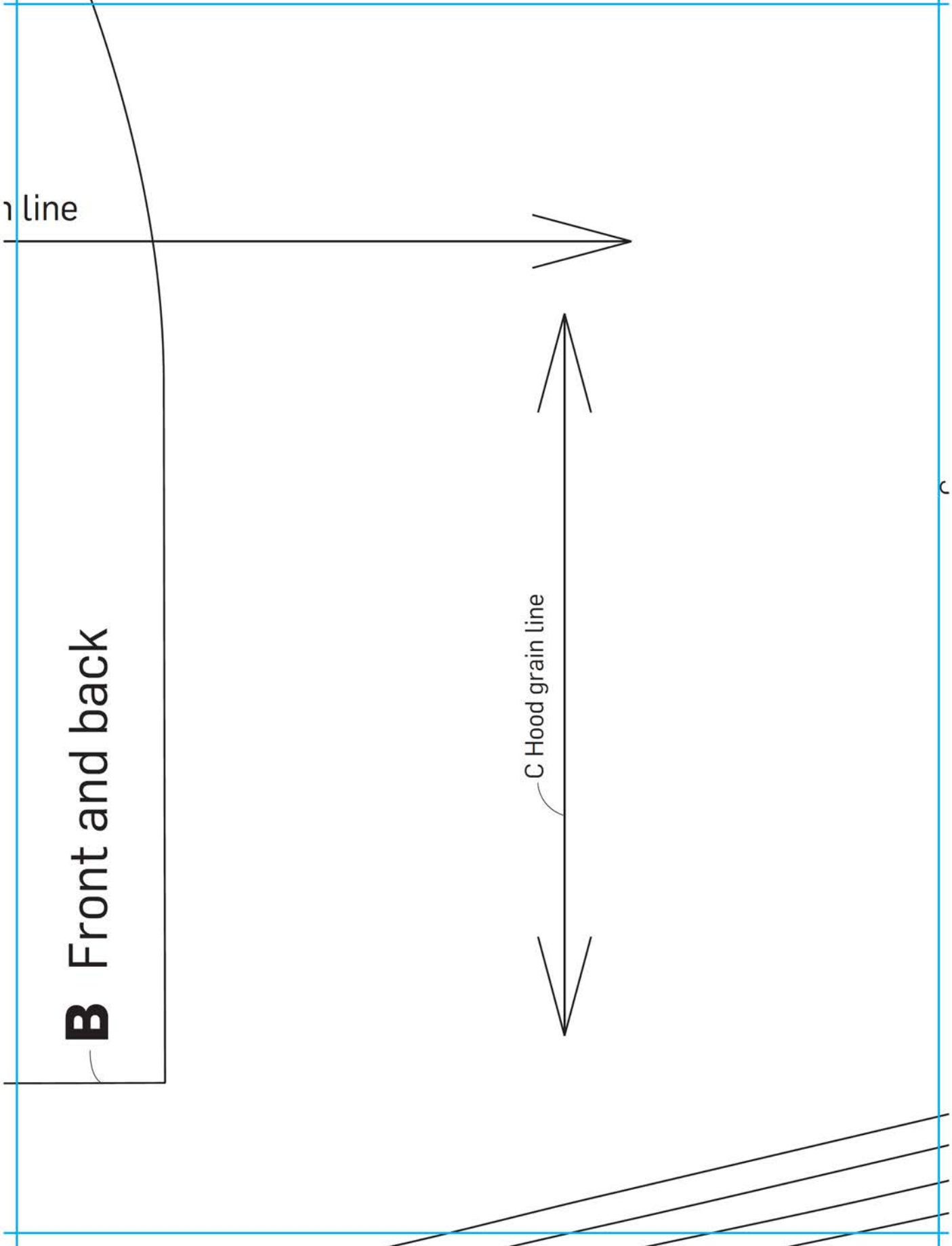

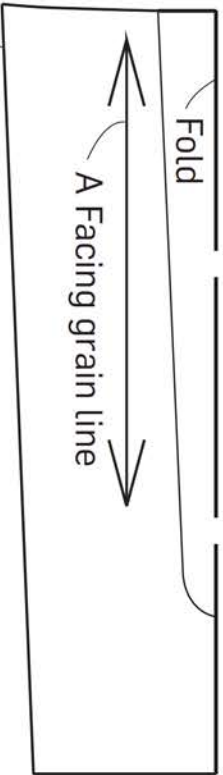

A Facing

A Front and back center fold

C6

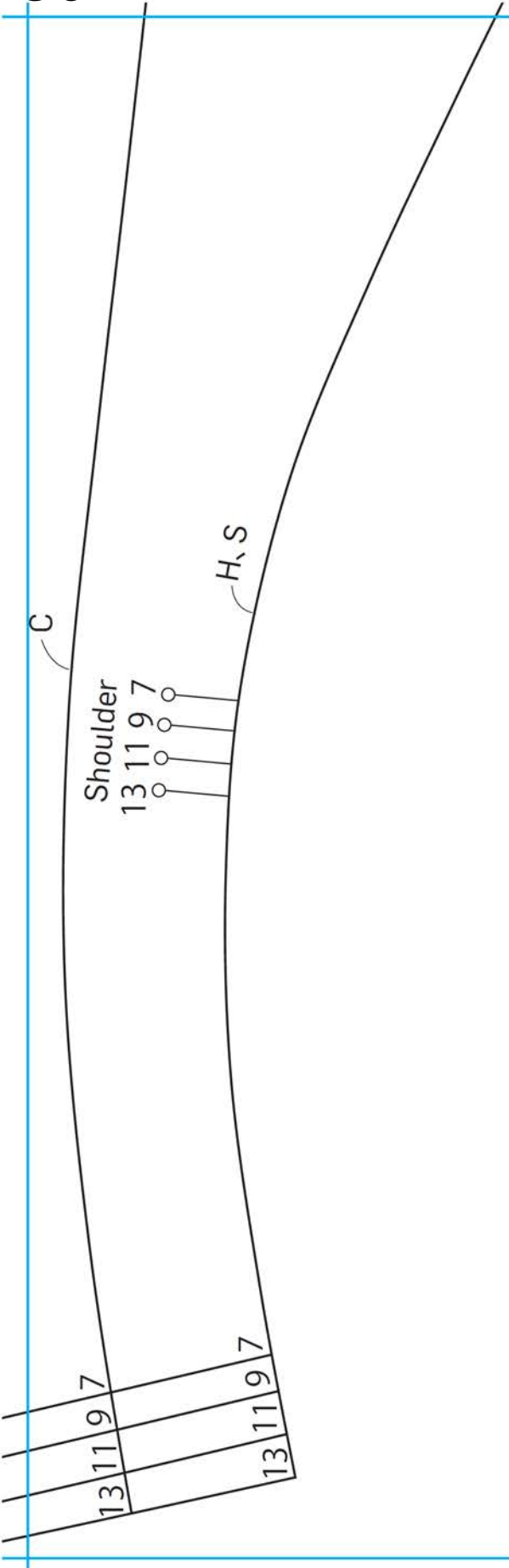

D1

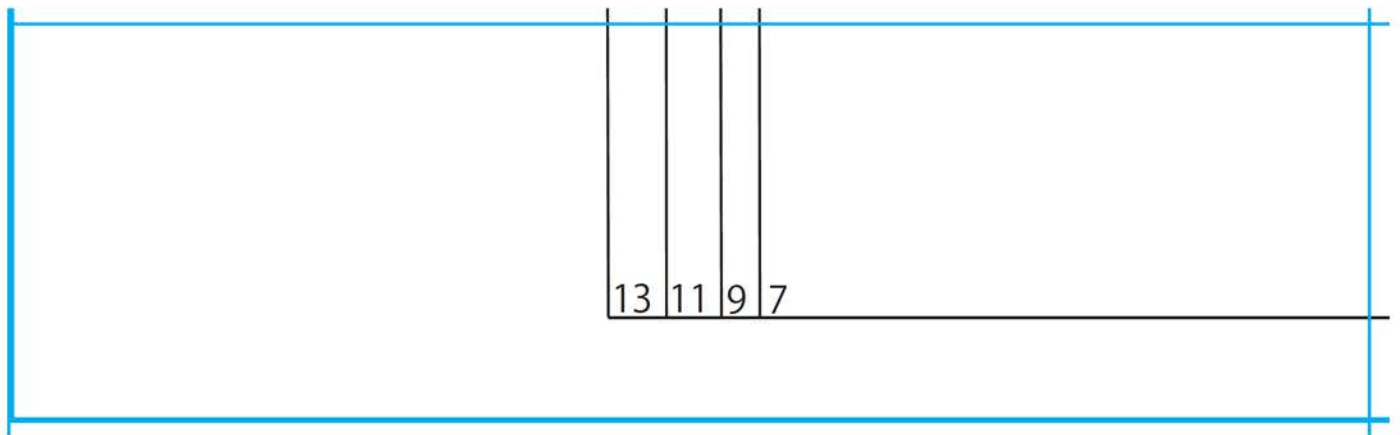

D2

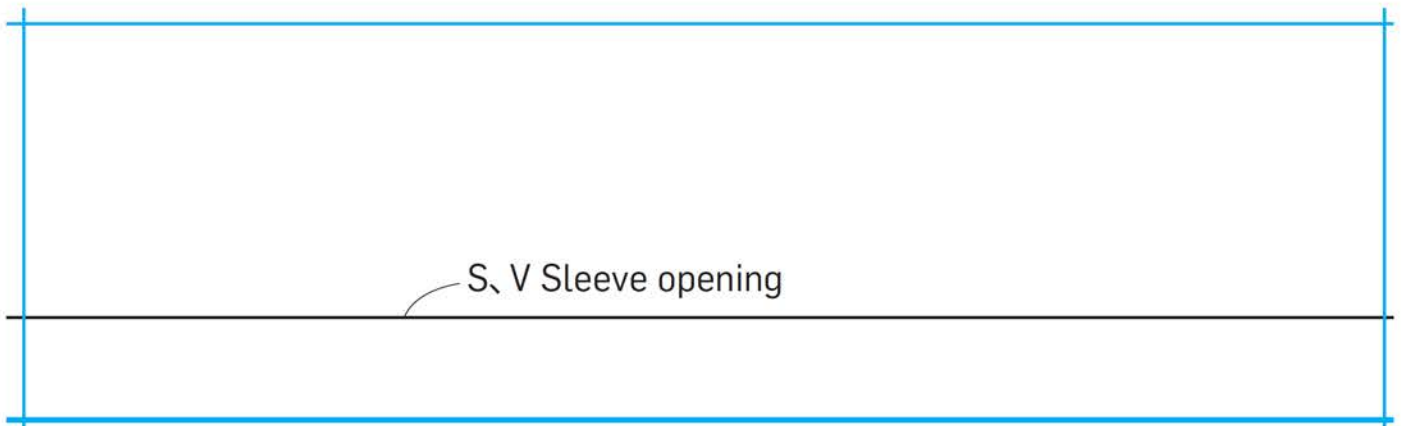

D3

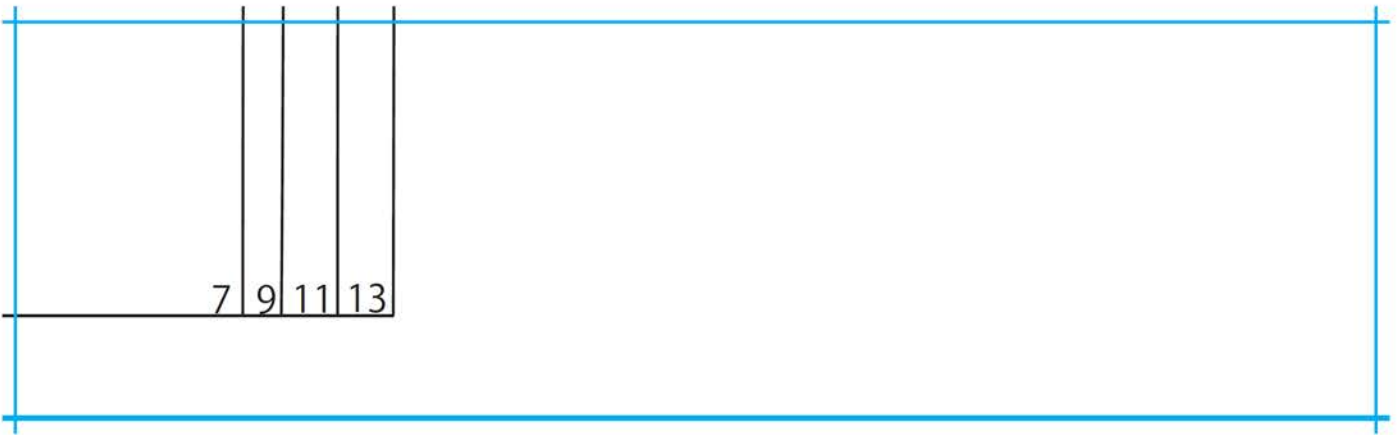

D4

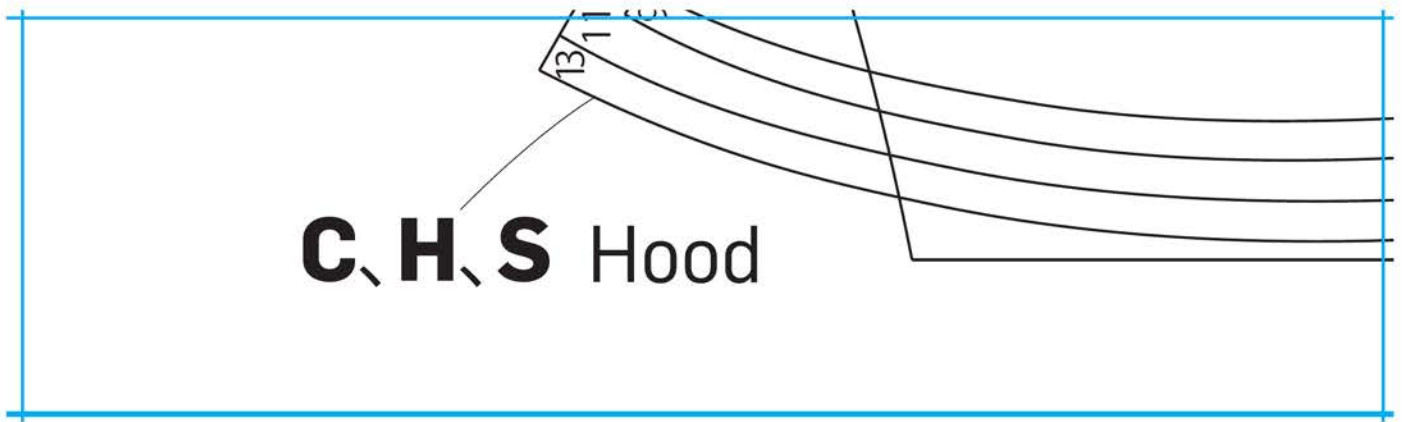

D5

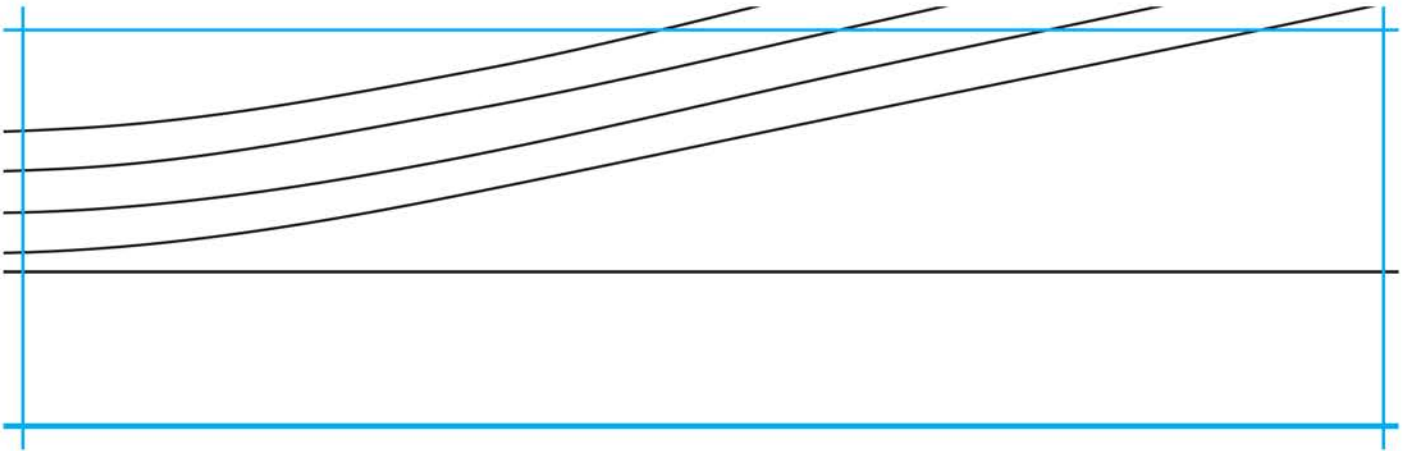

D6



A Front and back