

A1

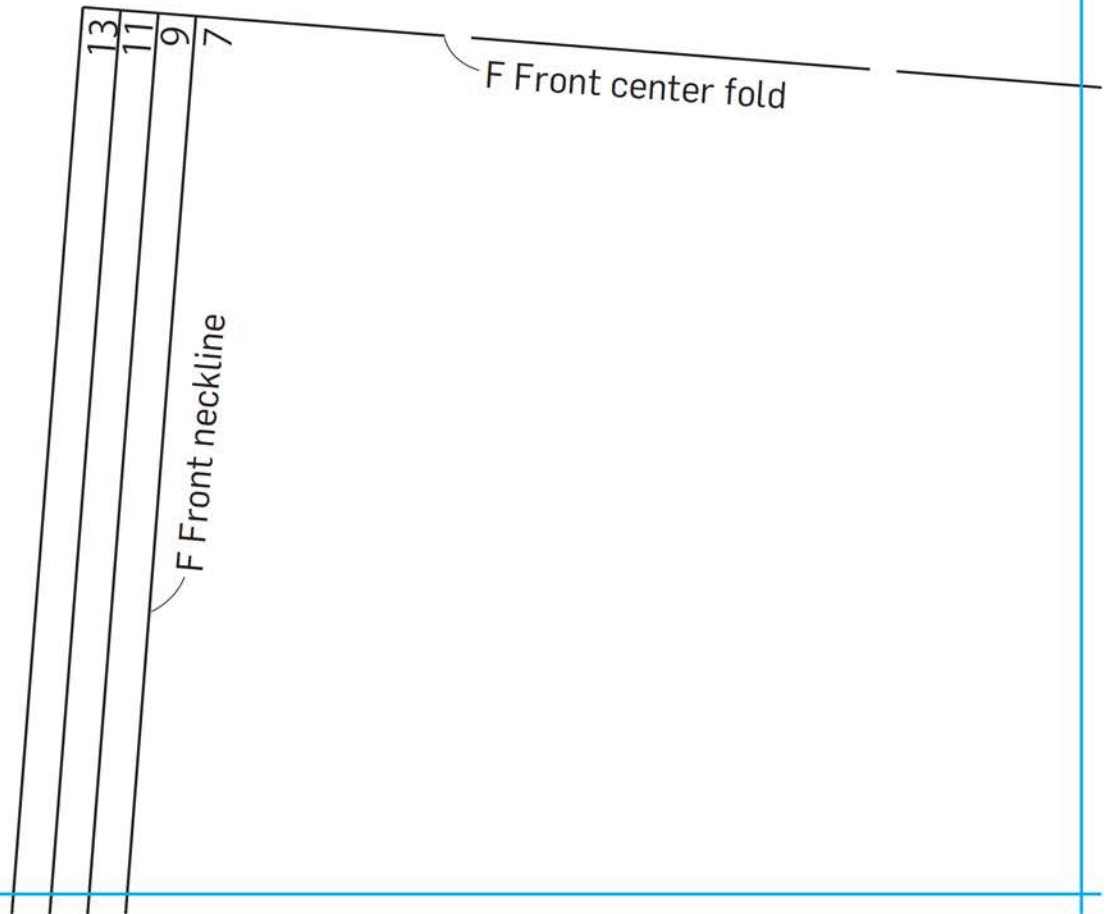

A2

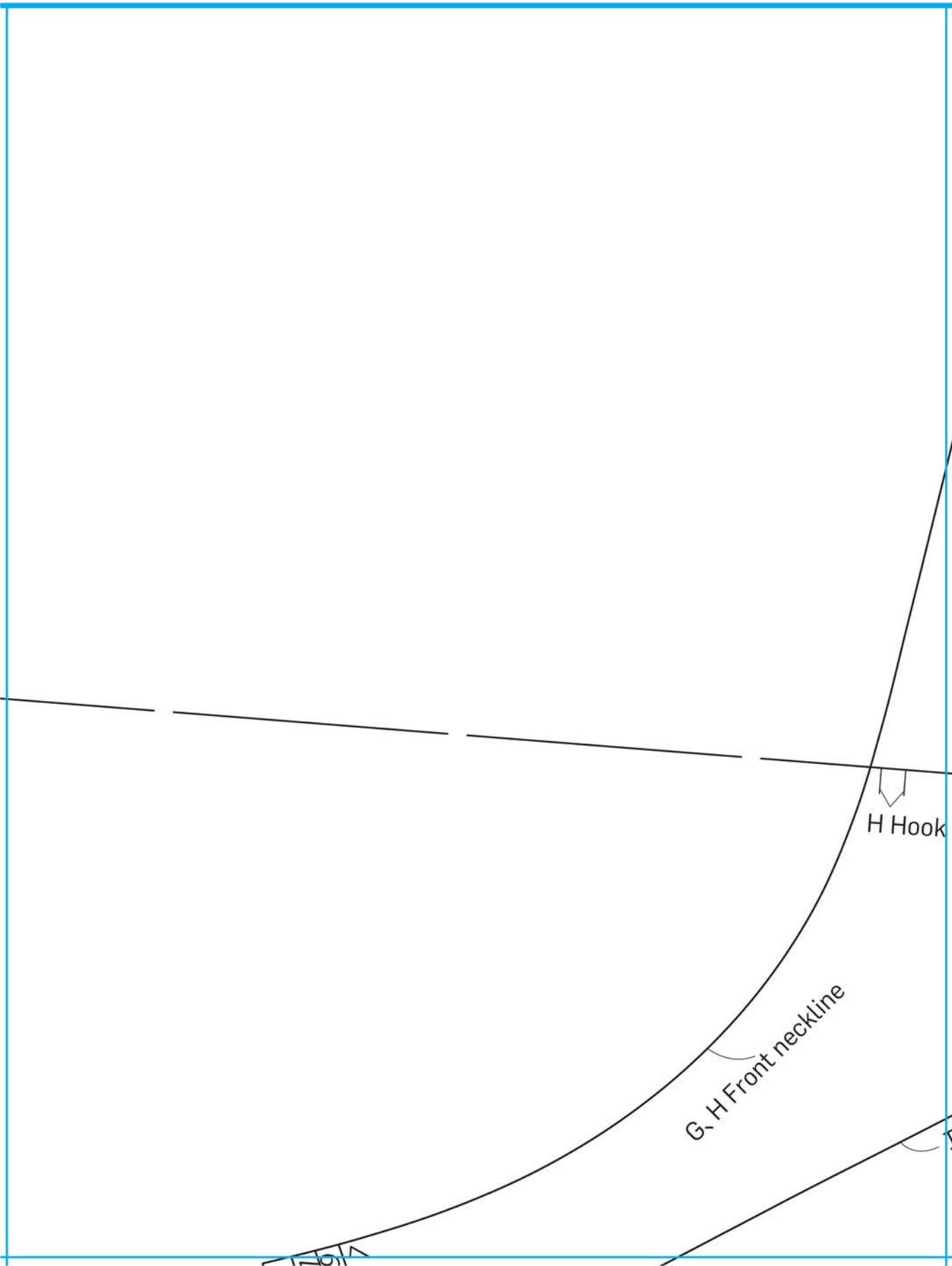

# A3

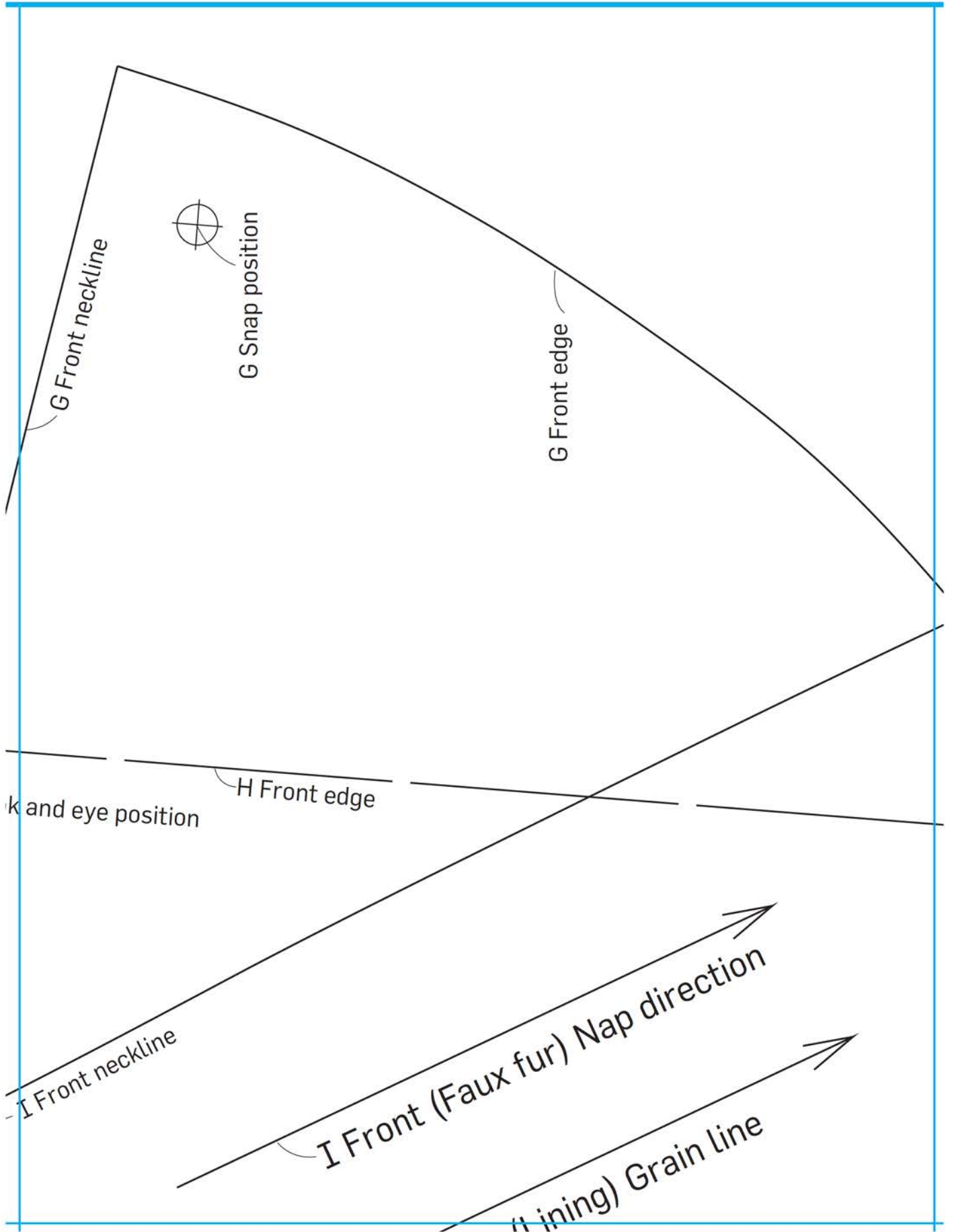

A4

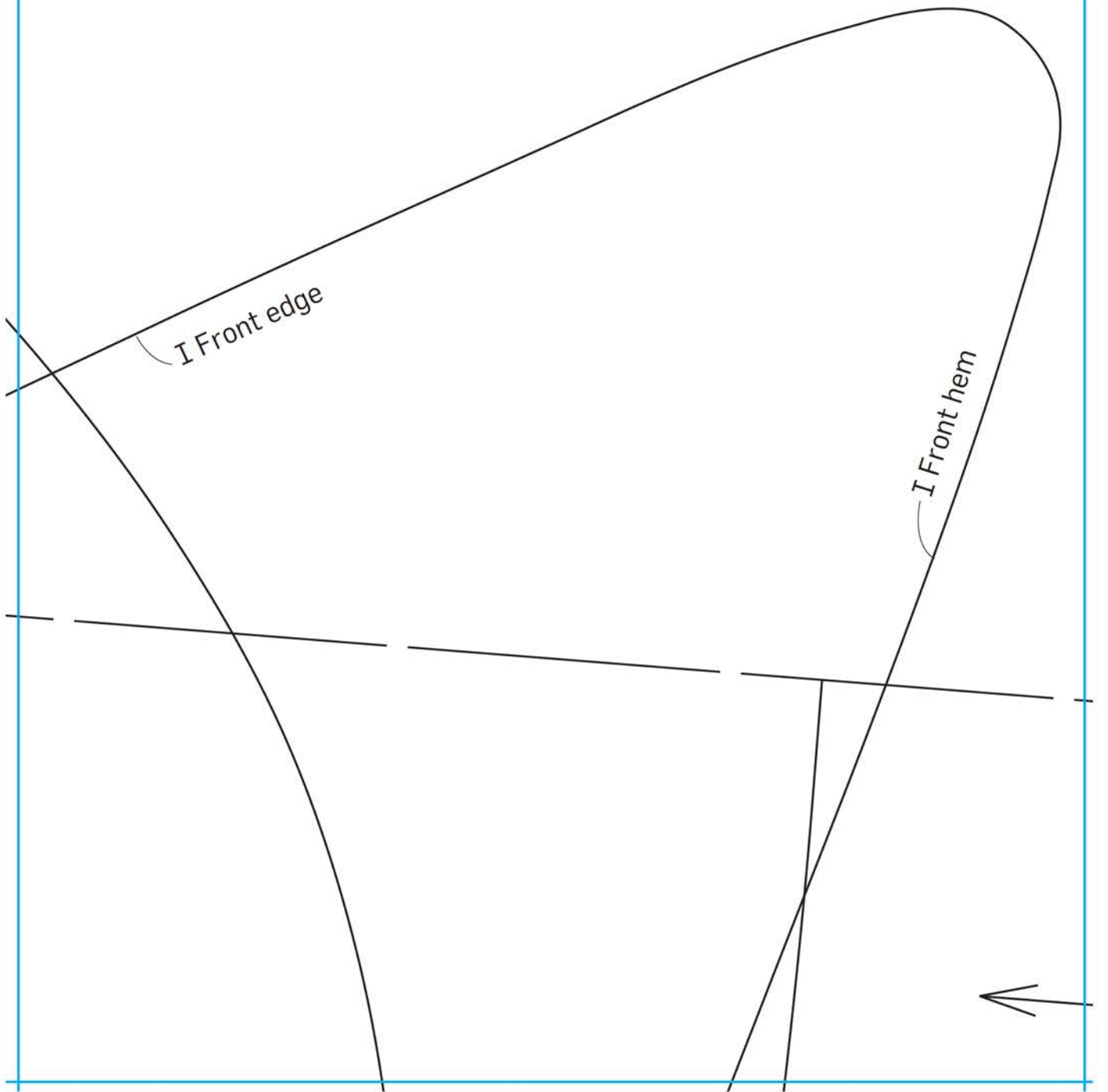
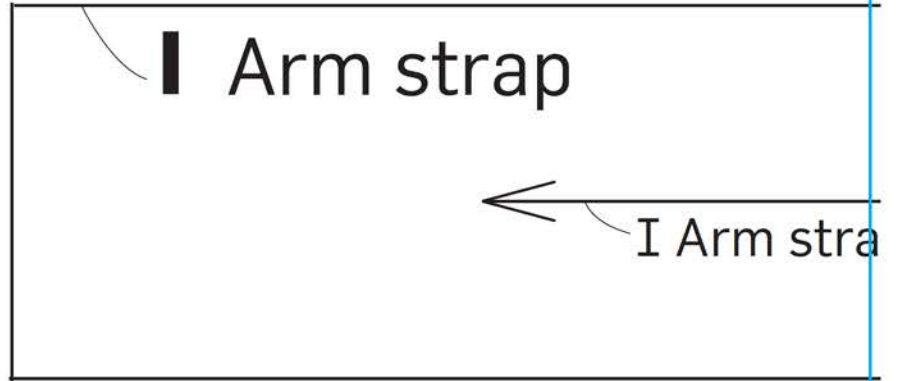

# A5

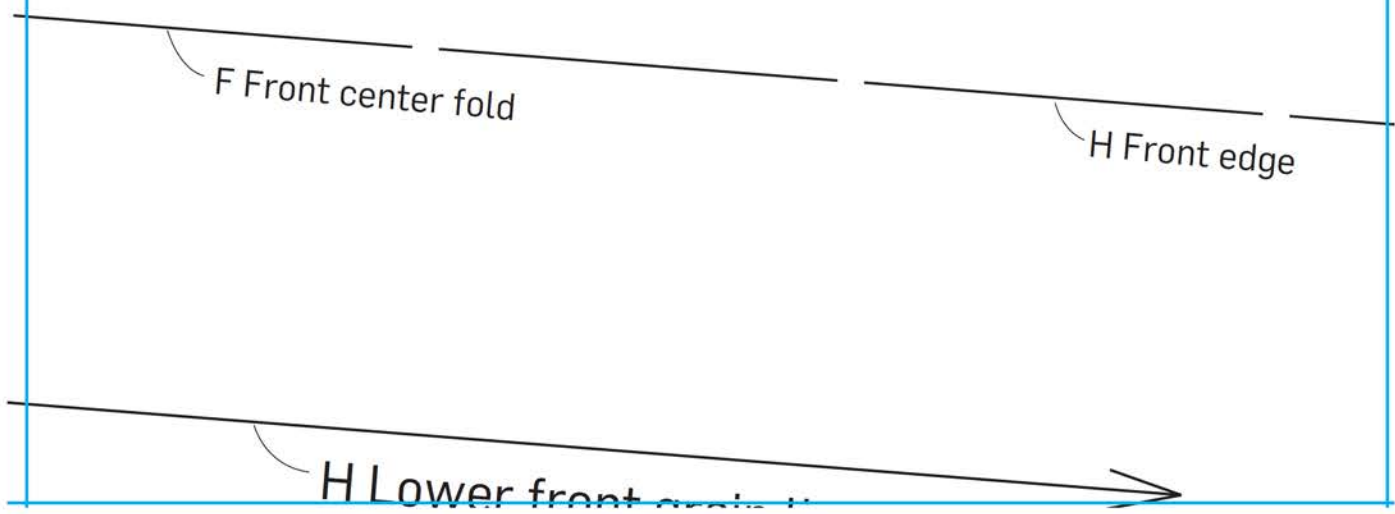
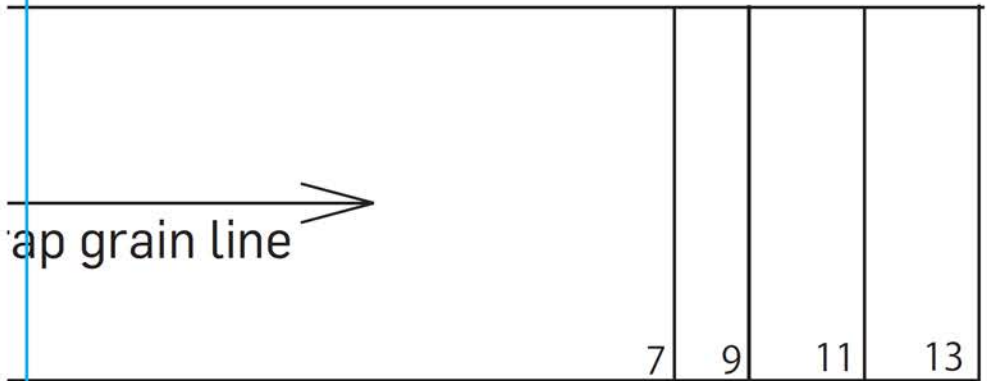

# Stylish Wraps

## *Sewing Book*

© 2011 Yoshiko Tsukiori  
 Bunka Publishing Bureau  
 English Translation © 2017  
 Periplus Editions (HK), Ltd.

Ponchos, Capes, Coats and  
 More—Fashionable Warmers  
 That are Easy to Sew

FULL SIZE PATTERN SHEET

## B SIDE

### PATTERN 2

**F** Front and Back

**G** Front and Back

**H** Upper Front, Lower Front, Back

**I** Front, Back, Arm Strap

- \* No seam allowances are printed on the pattern sheets. Please refer to the cutting layout diagrams in the main text and add seam allowances when transferring patterns to paper.
- \* Patterns are not given for some ruffles, loops and other pieces. Please refer to the main text for these also and draft the patterns yourself or mark them out directly onto the fabric.
- \* Four sizes are given on the pattern sheet unless otherwise specified (7, 9, 11, 13). Please use the chart on page 29 of the book when selecting your size.
- \* Please note that depending on the type of paper and tracing tools used, there may be slight variations in measurements.

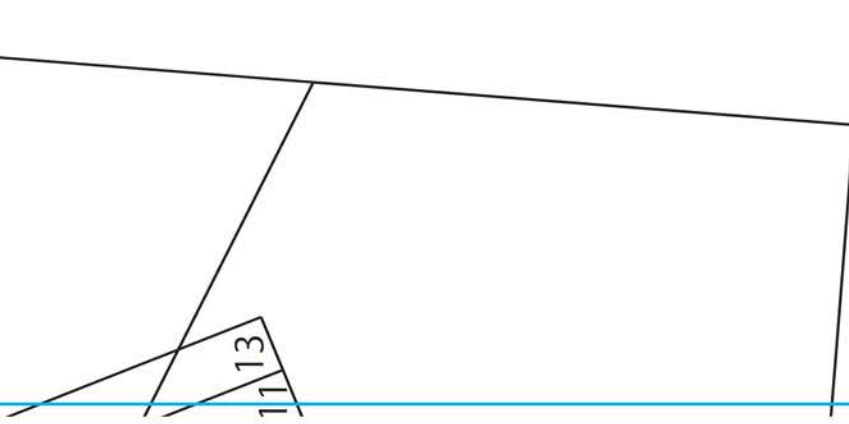

**B1**

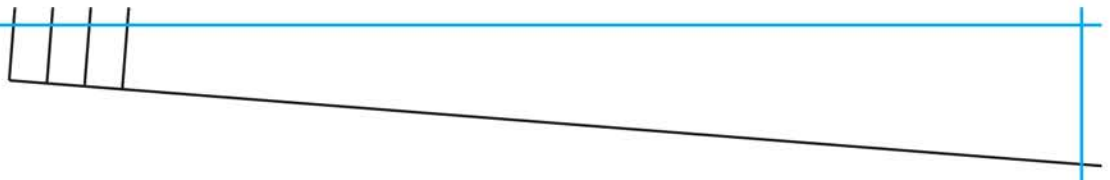

**U**

**B2**

**F'**

**G'**

**I**

Front

**H**

Upper front

13  
11  
9

13  
11  
9  
7

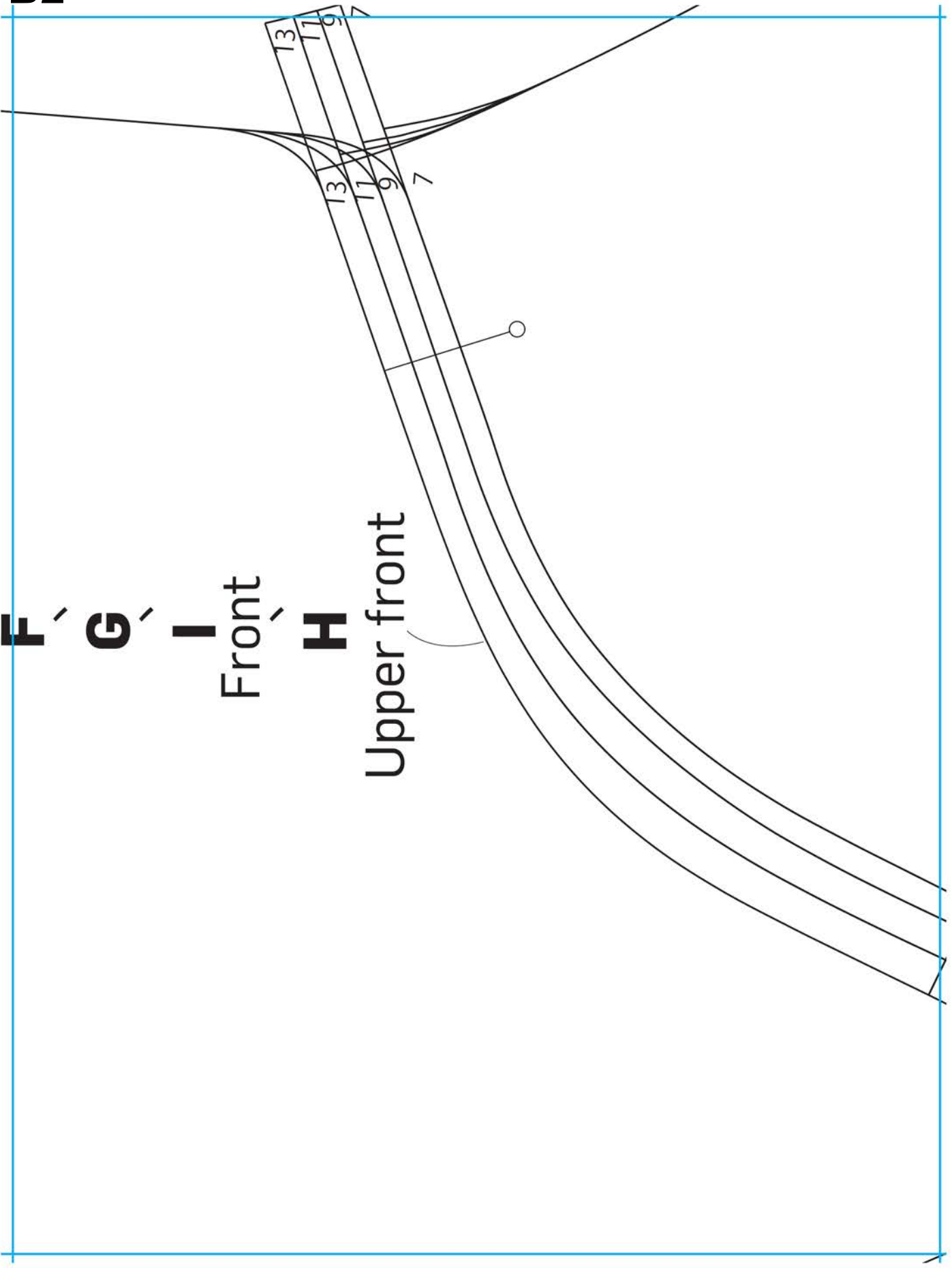



# B3

G Snap position



I Front (Linen)

F, G Front, H Upper front grain line

I Arm strap attachment position (Front)

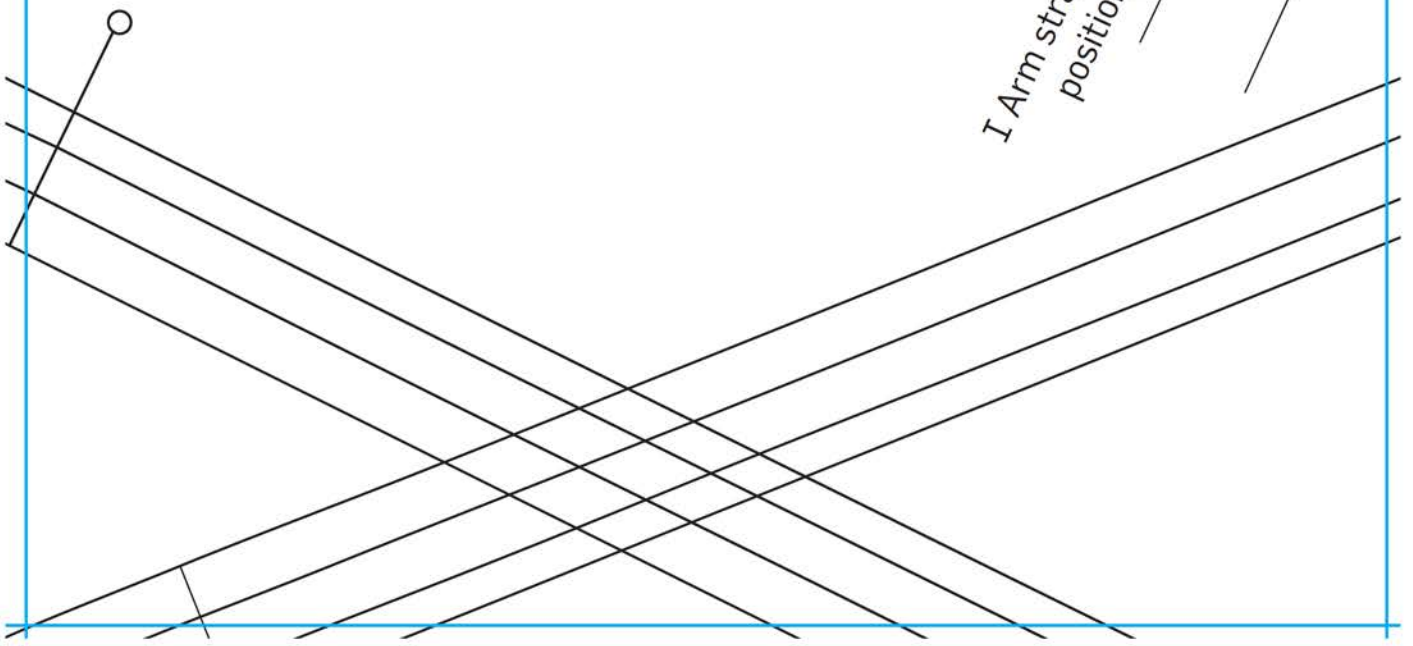

# B4

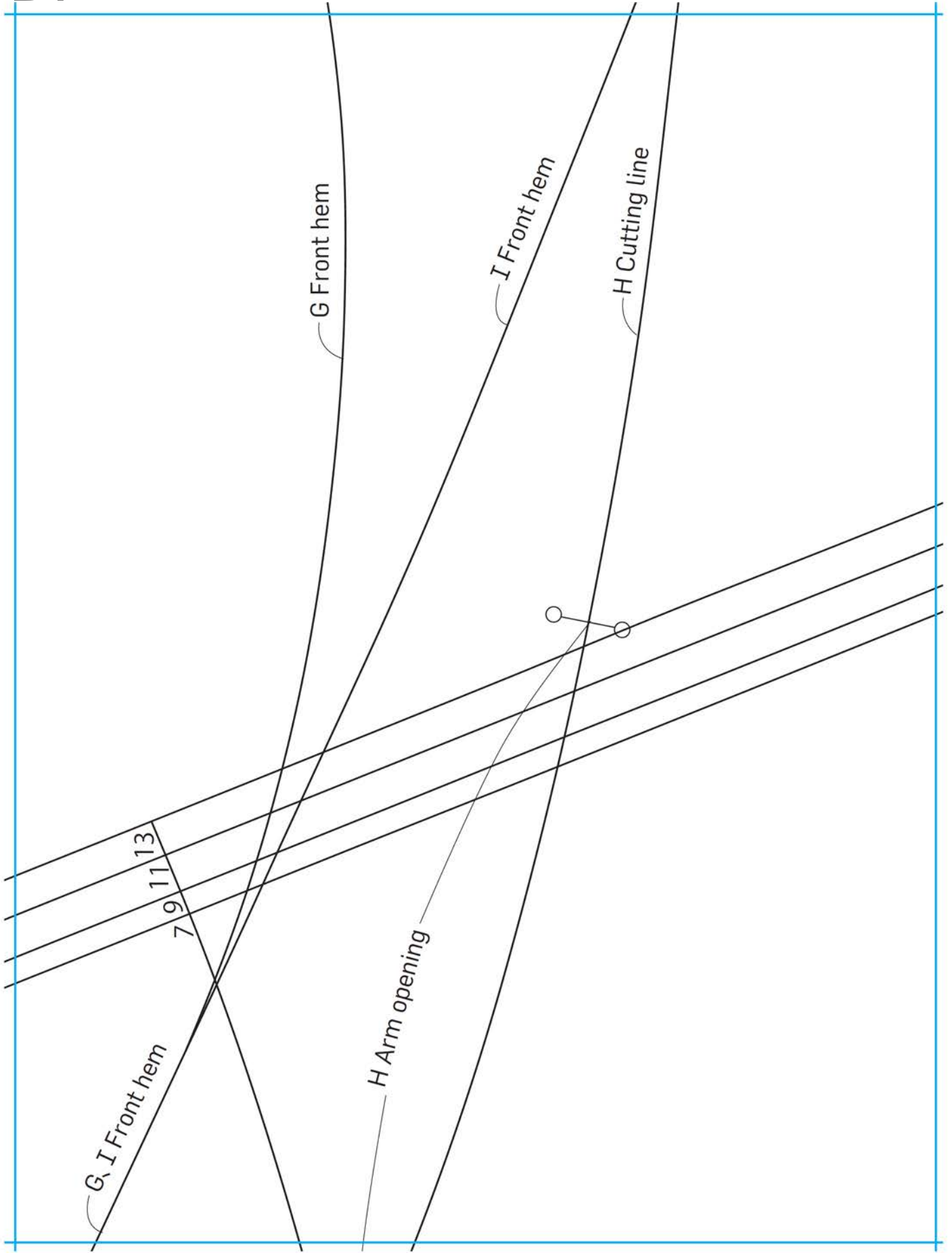

**B5**

|| Lower front grain line

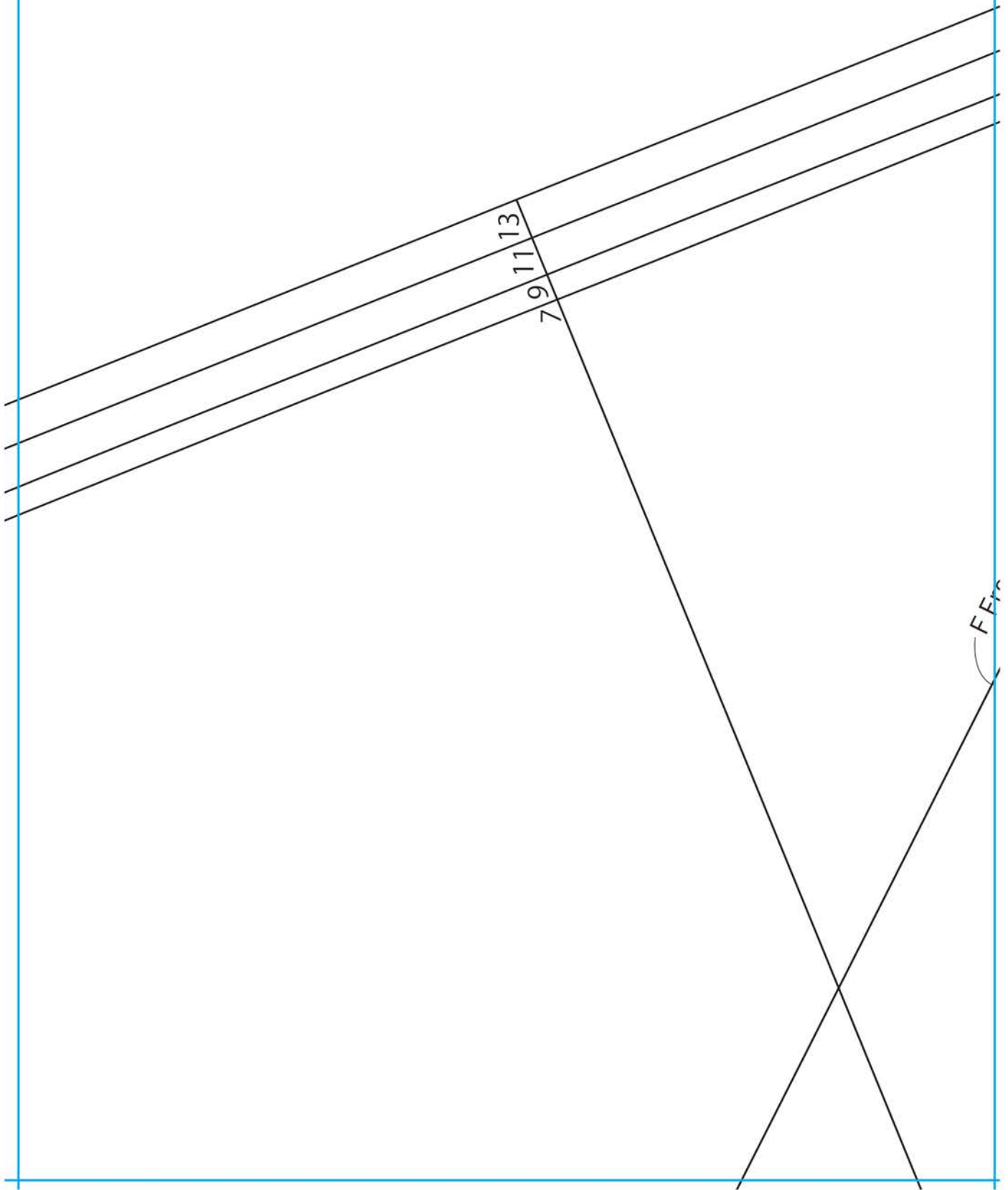

**B6**

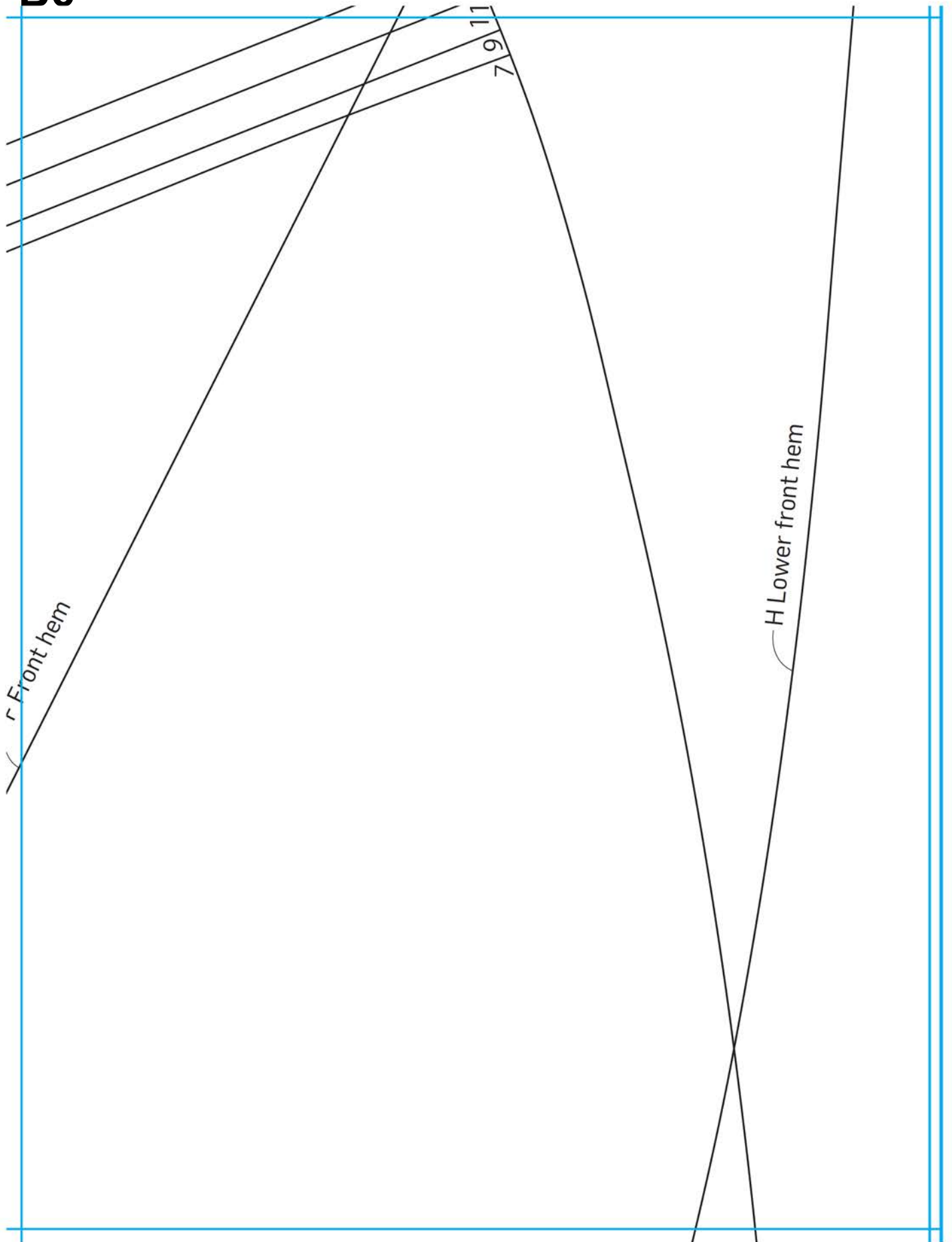

C1

13
11
9
7

: Back neckline

C2

**F' G' H' I**

Back

13  
11  
9  
7

13  
11  
9  
7

G, H Back neckline

I Back neckline



**C3**

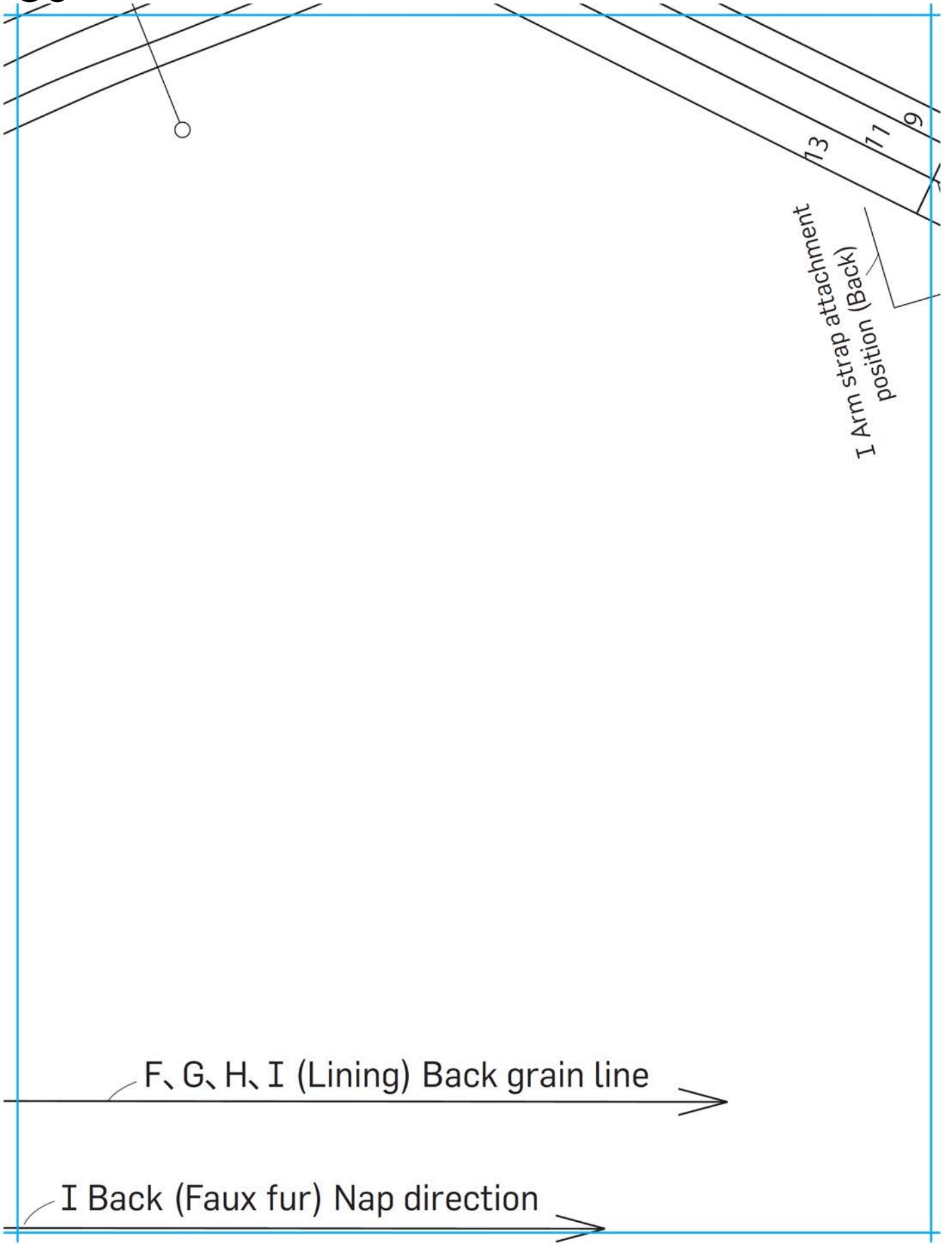

C4

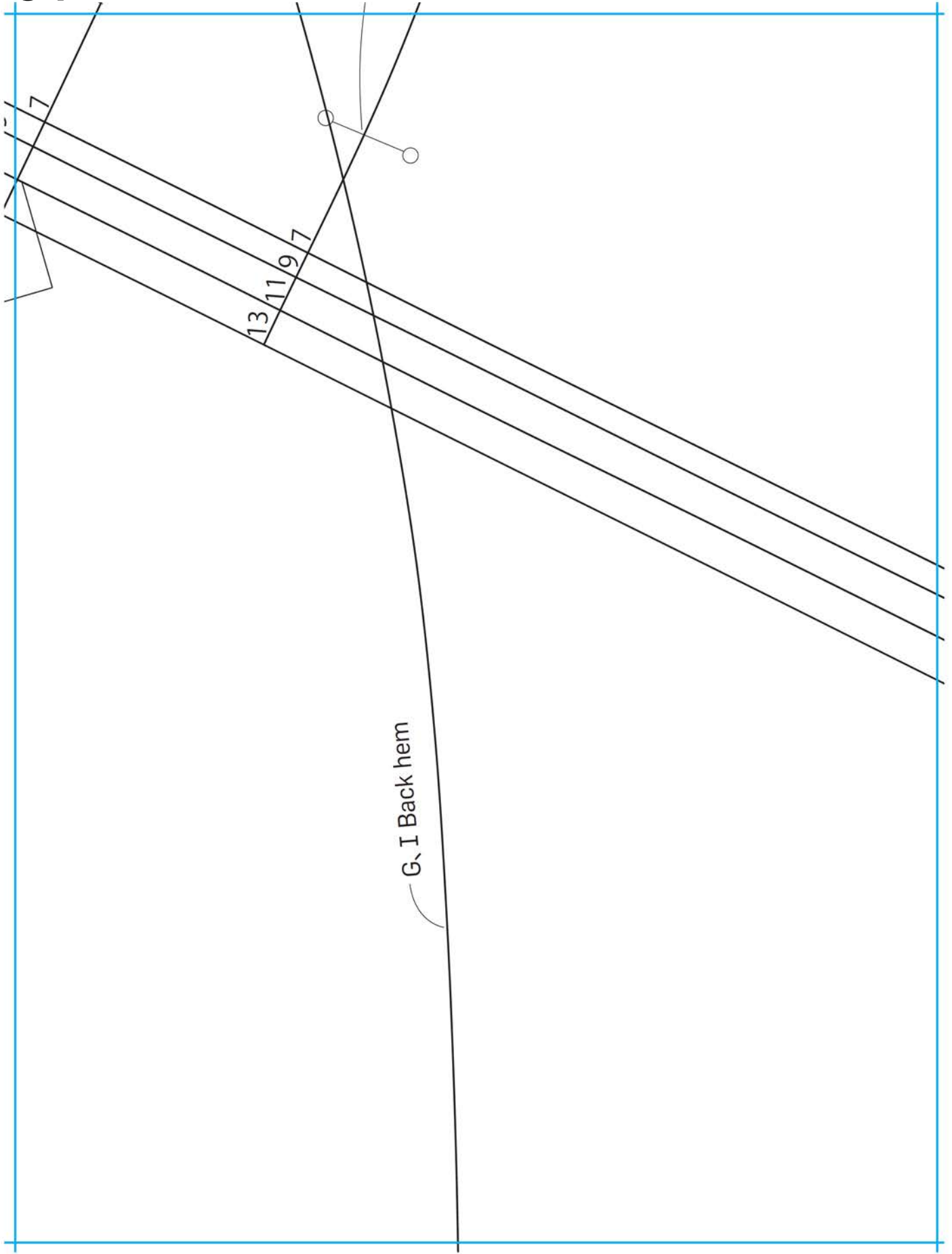



C5

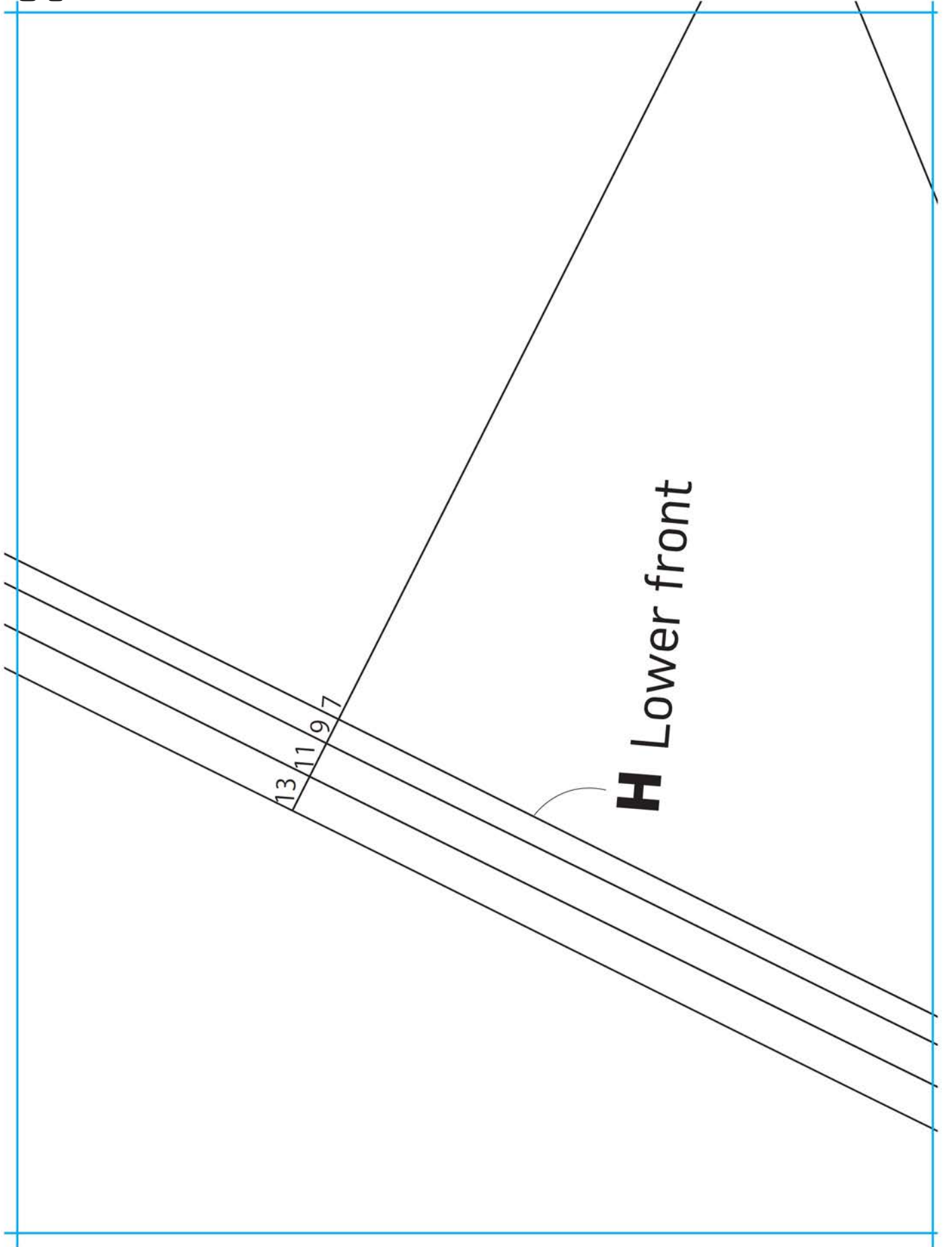

C6

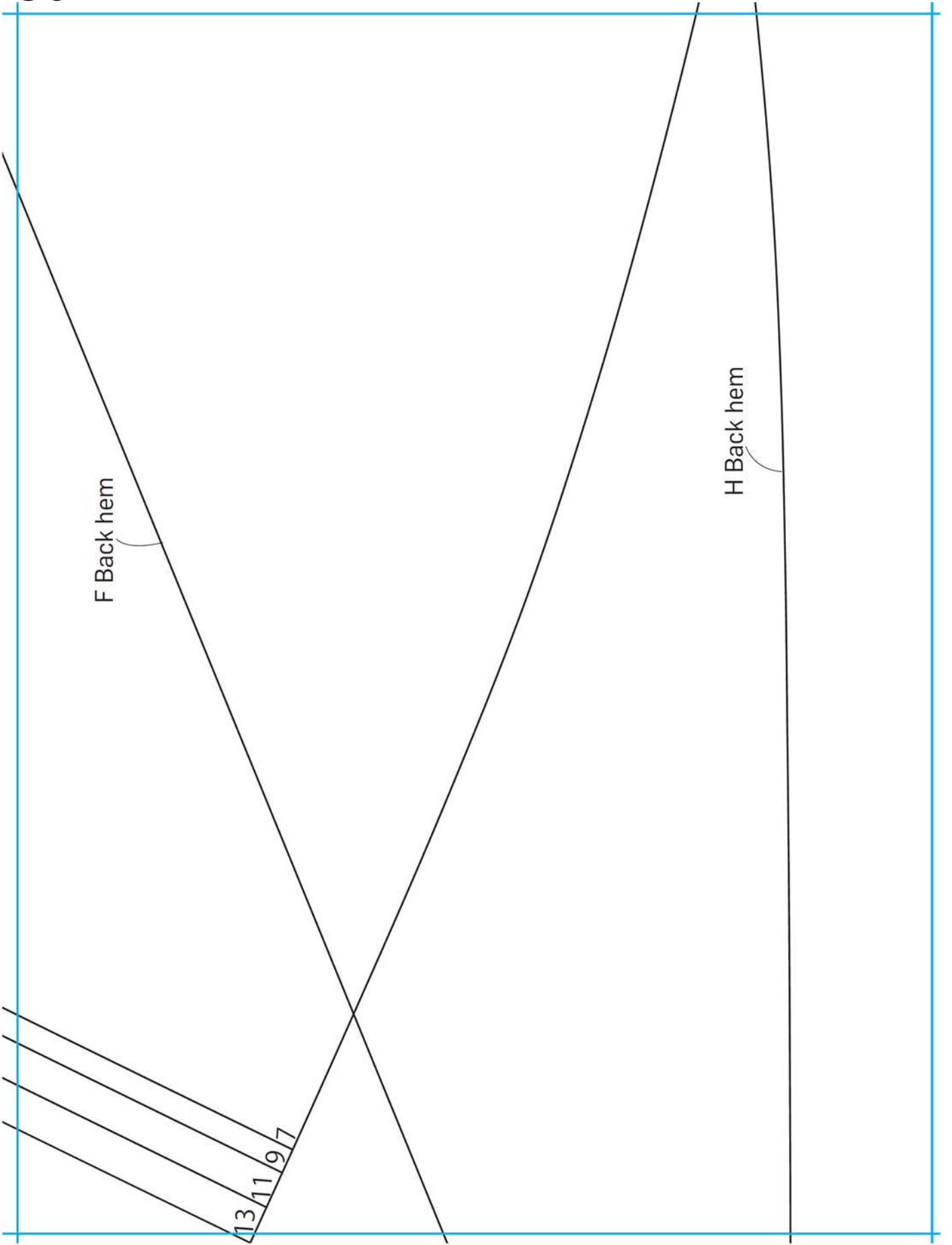

D1

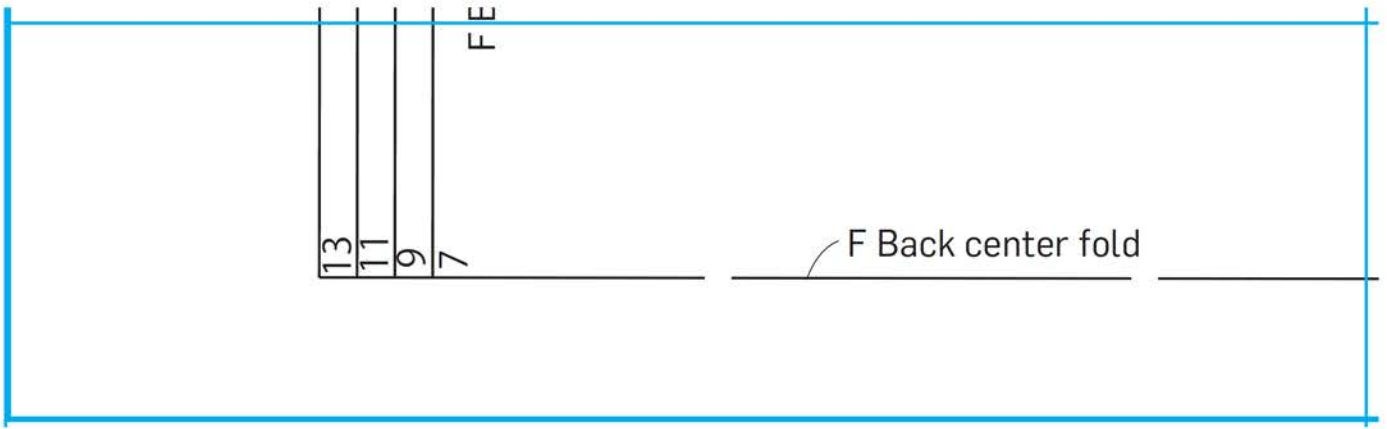

D2

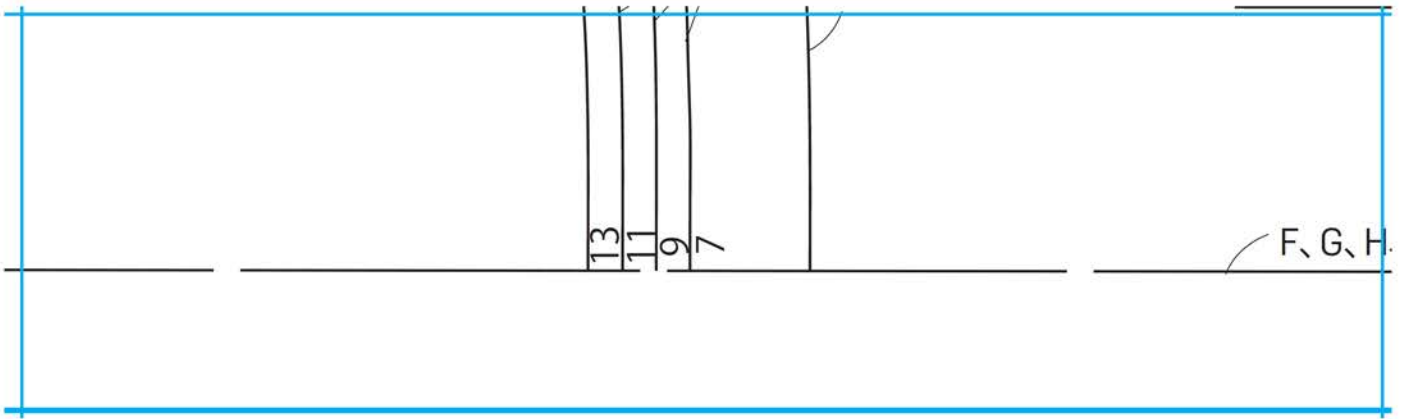

# D3

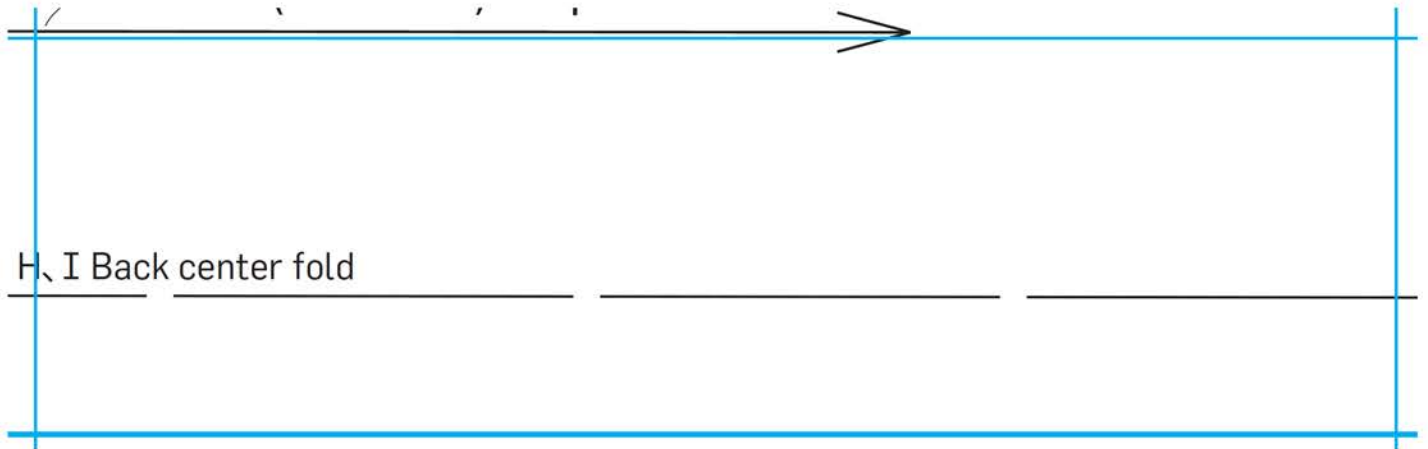

D4

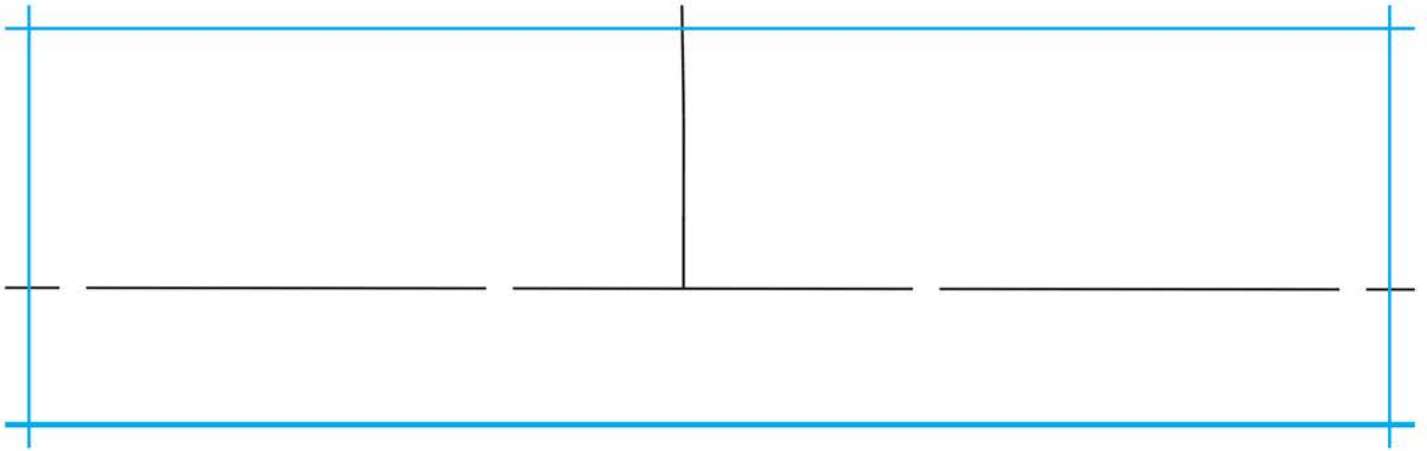

**D5**

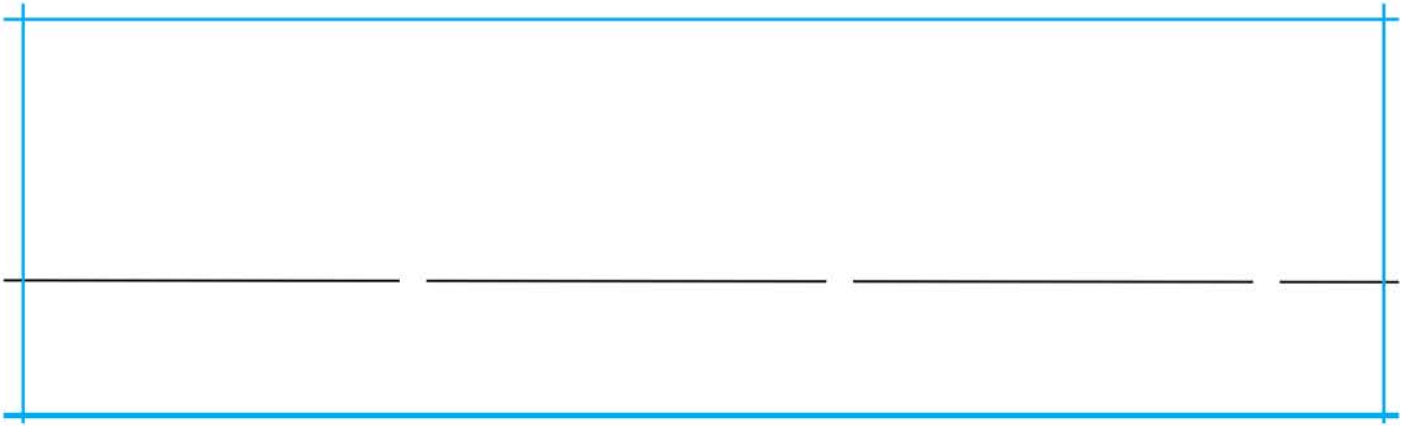

D6

