

Print on 60lb to 120lb 8.5" x 11" card stock. Scaling 100%. Do not use your "fit to paper" option on your printer.

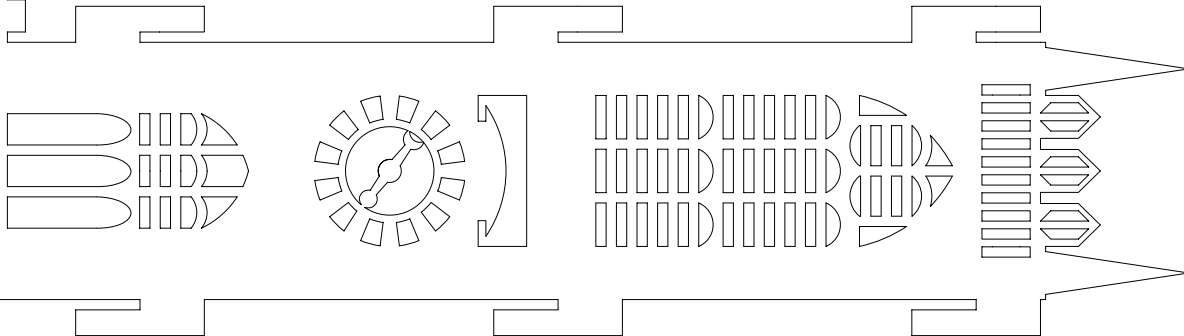

Y01

Y04

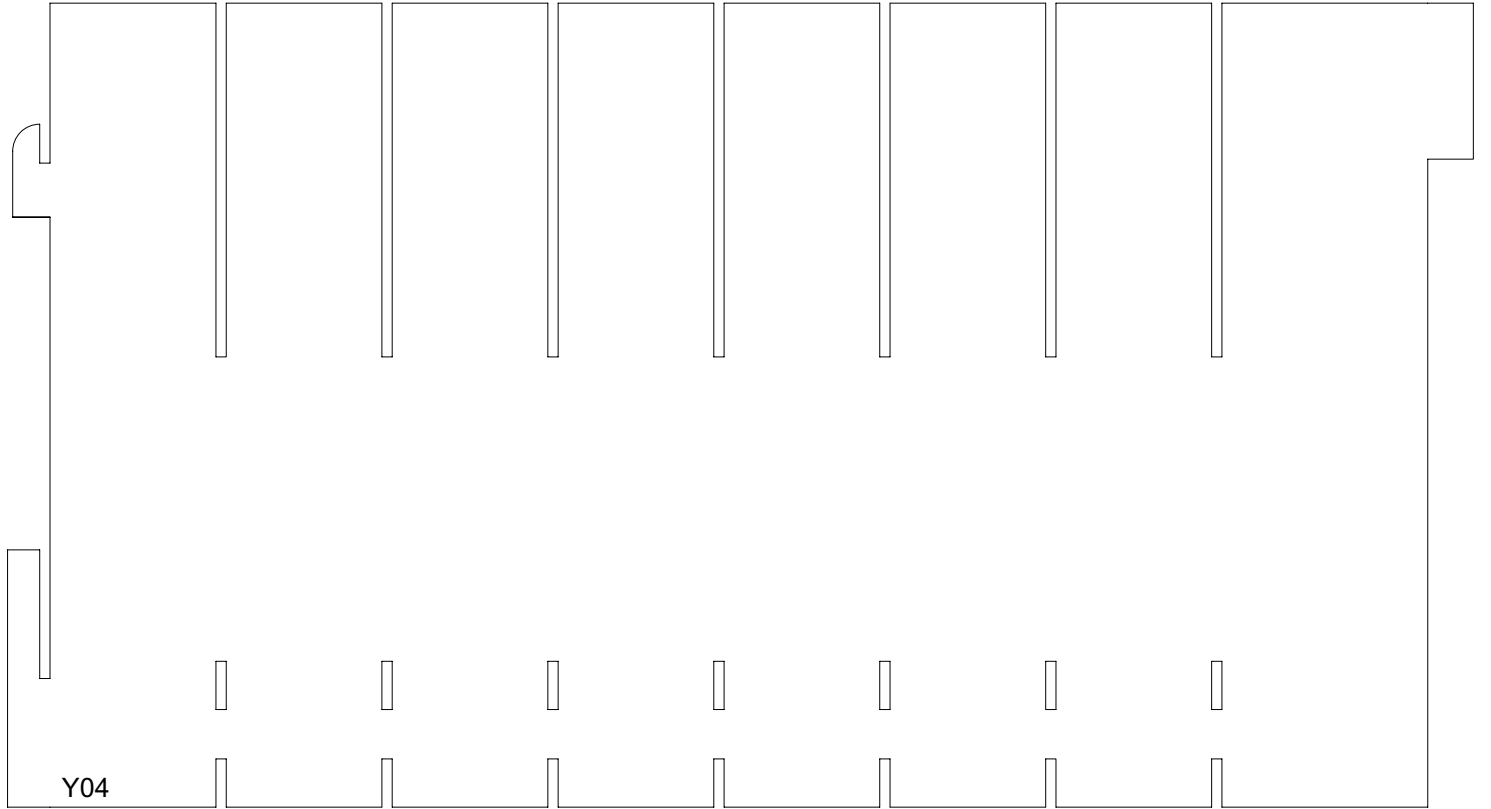
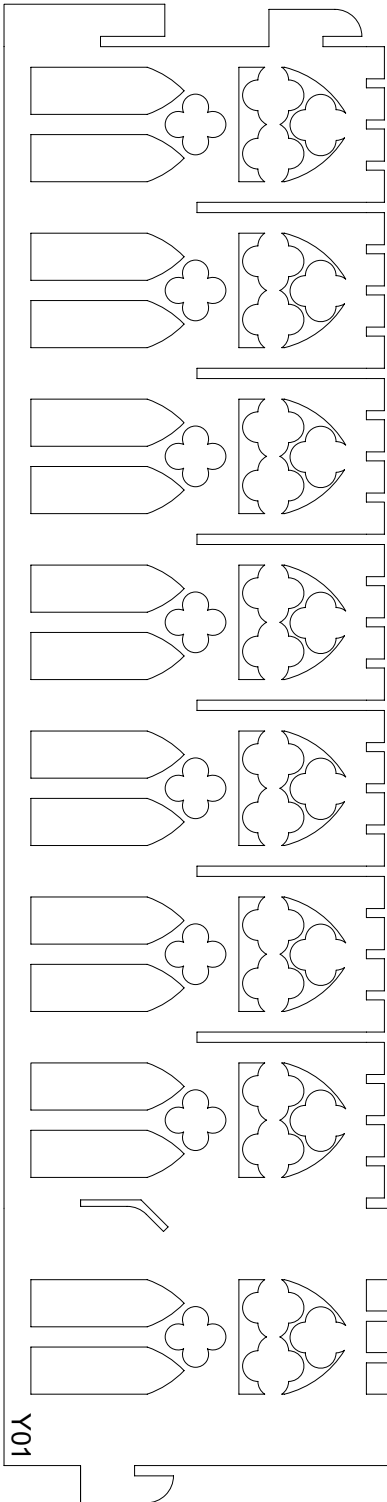
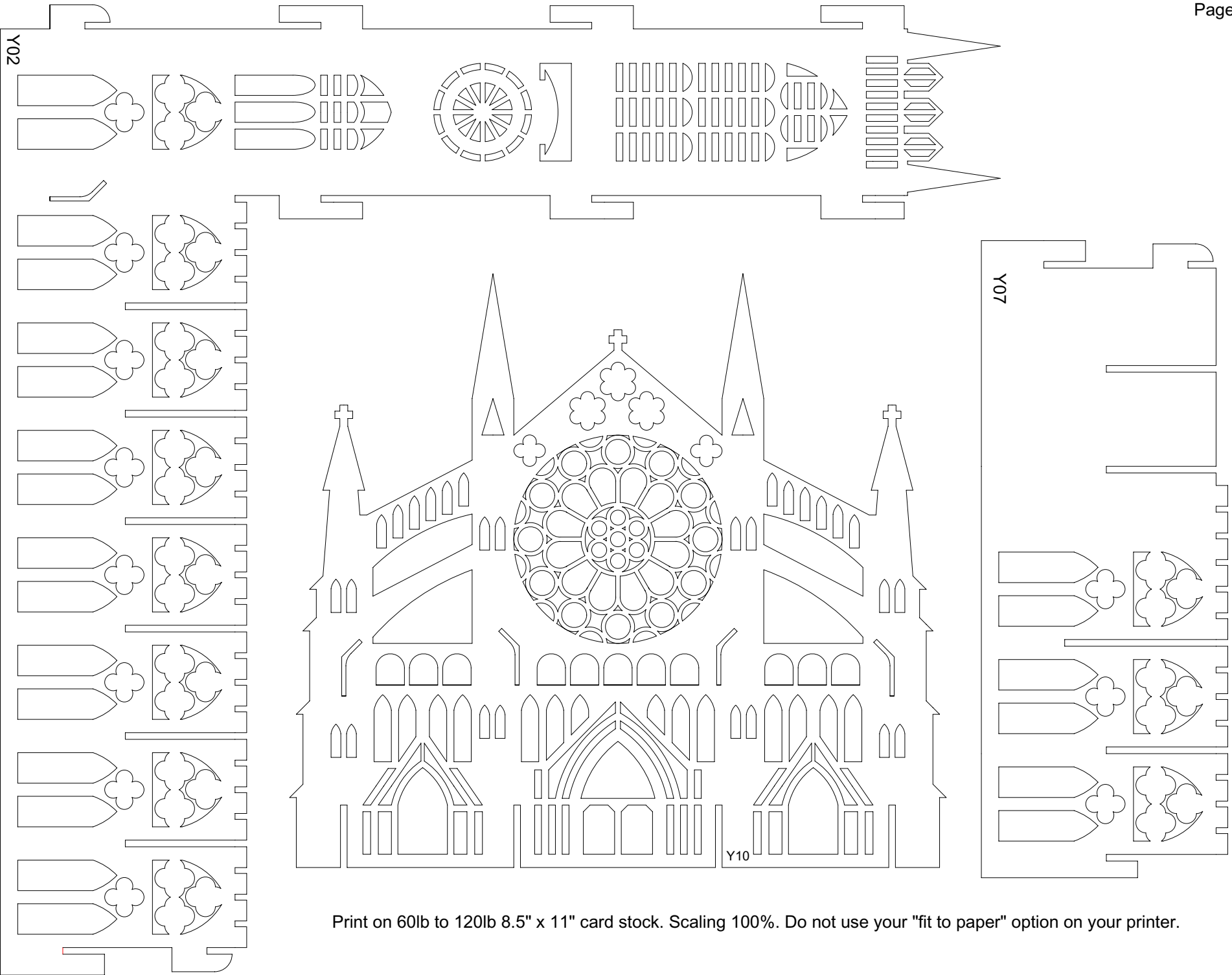

Print on 60lb to 120lb 8.5" x 11" card stock. Scaling 100%. Do not use your "fit to paper" option on your printer.

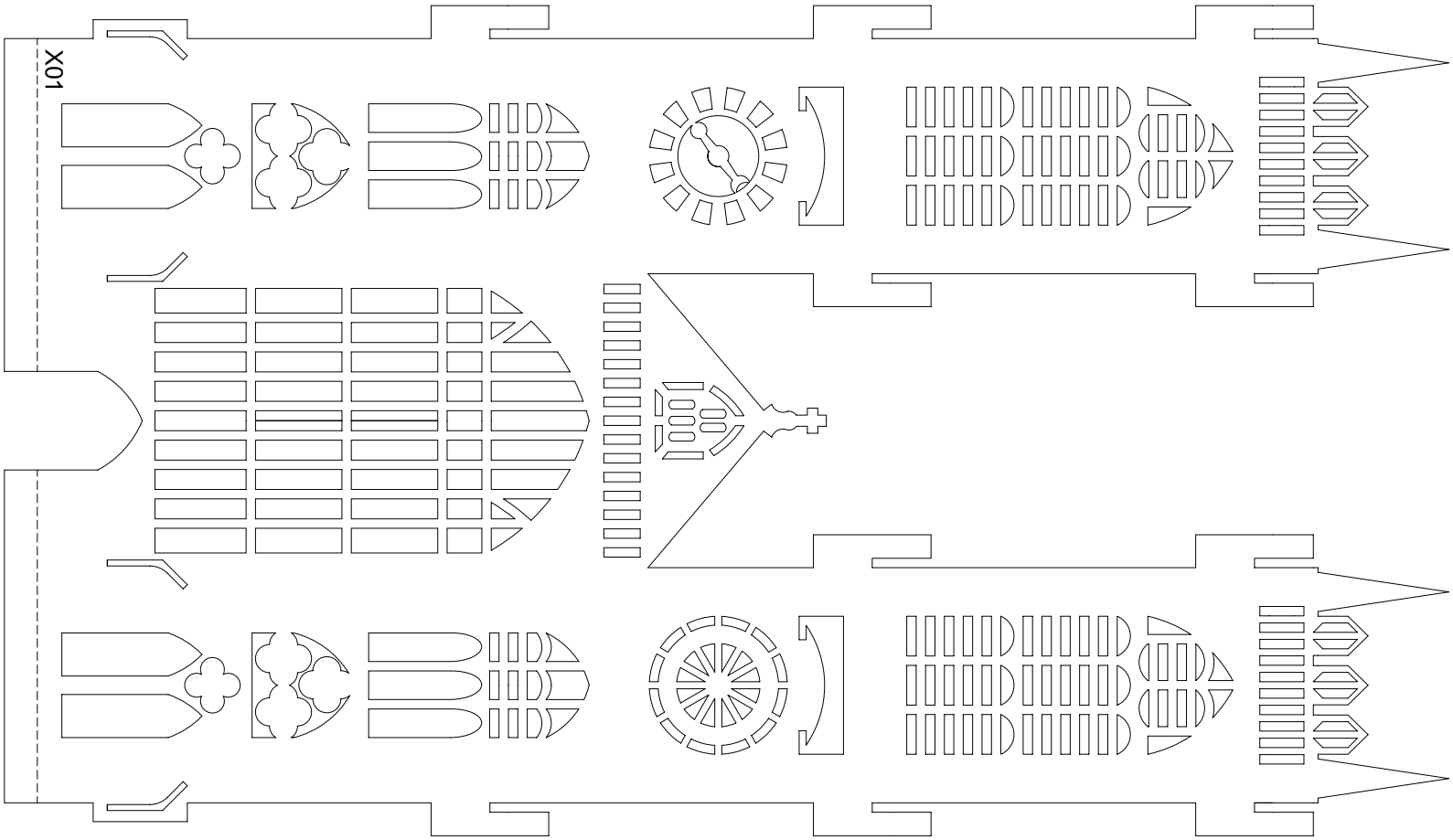
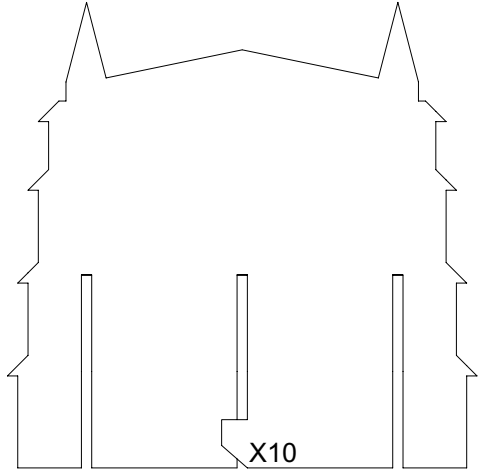
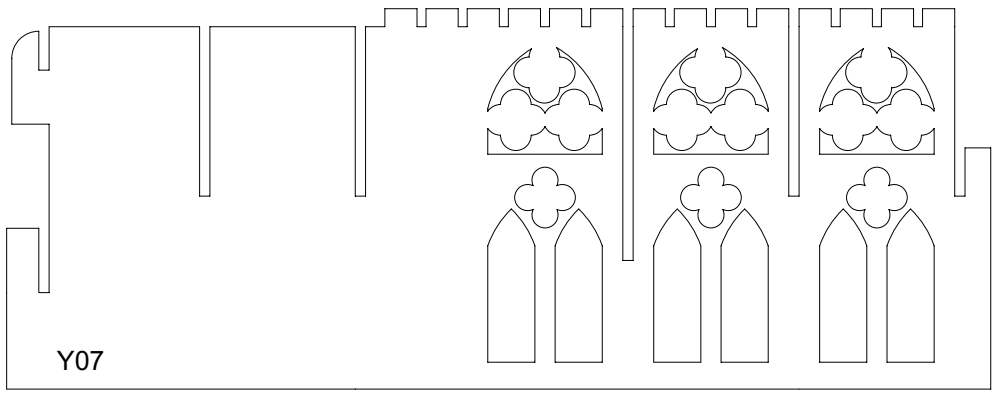

Print on 60lb to 120lb 8.5" x 11" card stock. Scaling 100%. Do not use your "fit to paper" option on your printer.

Print on 60lb to 120lb 8.5" x 11" card stock. Scaling 100%. Do not use your "fit to paper" option on your printer.

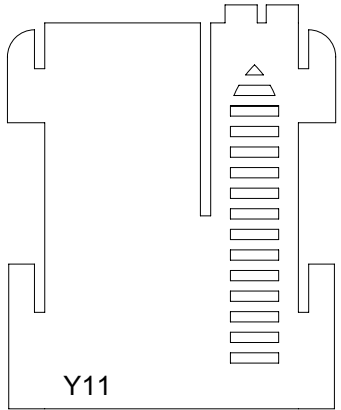
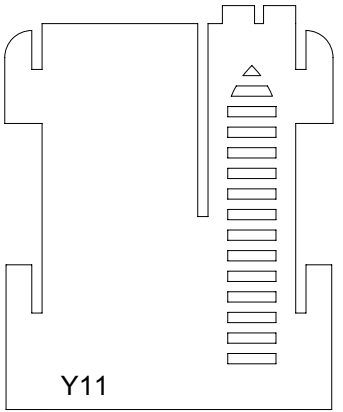
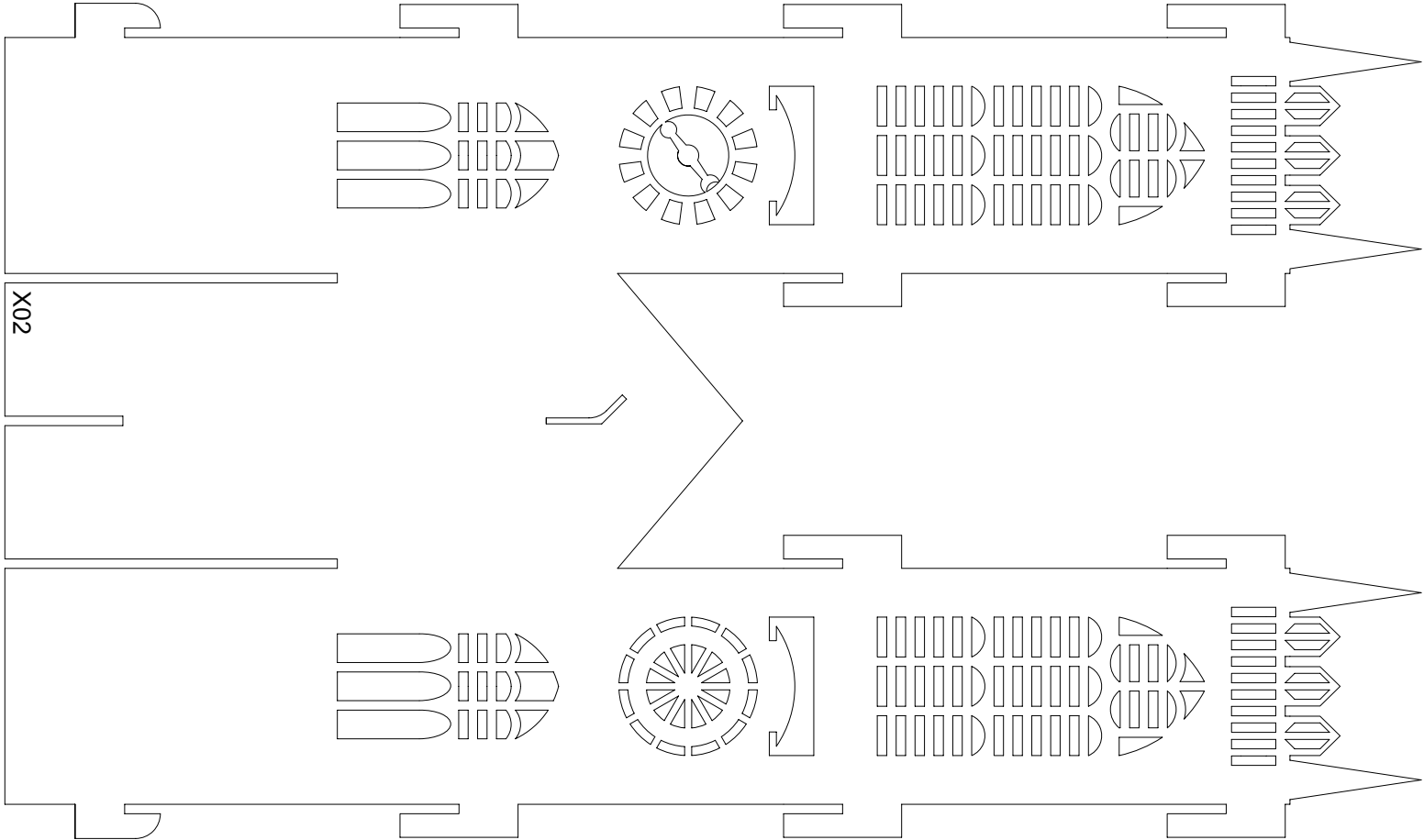
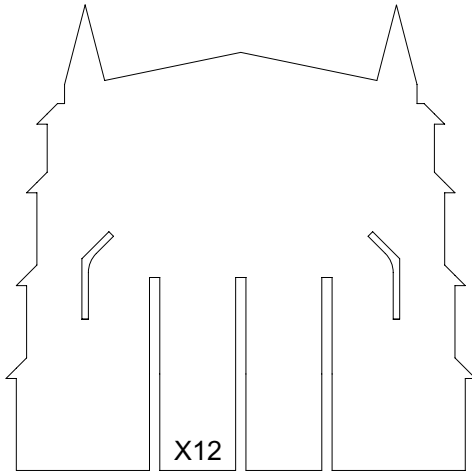
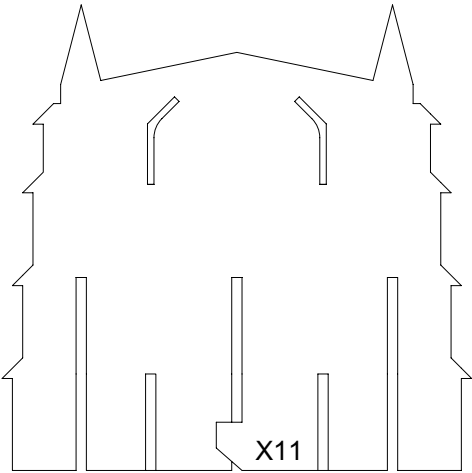
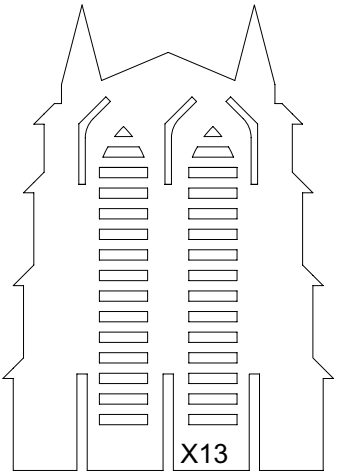

Y03

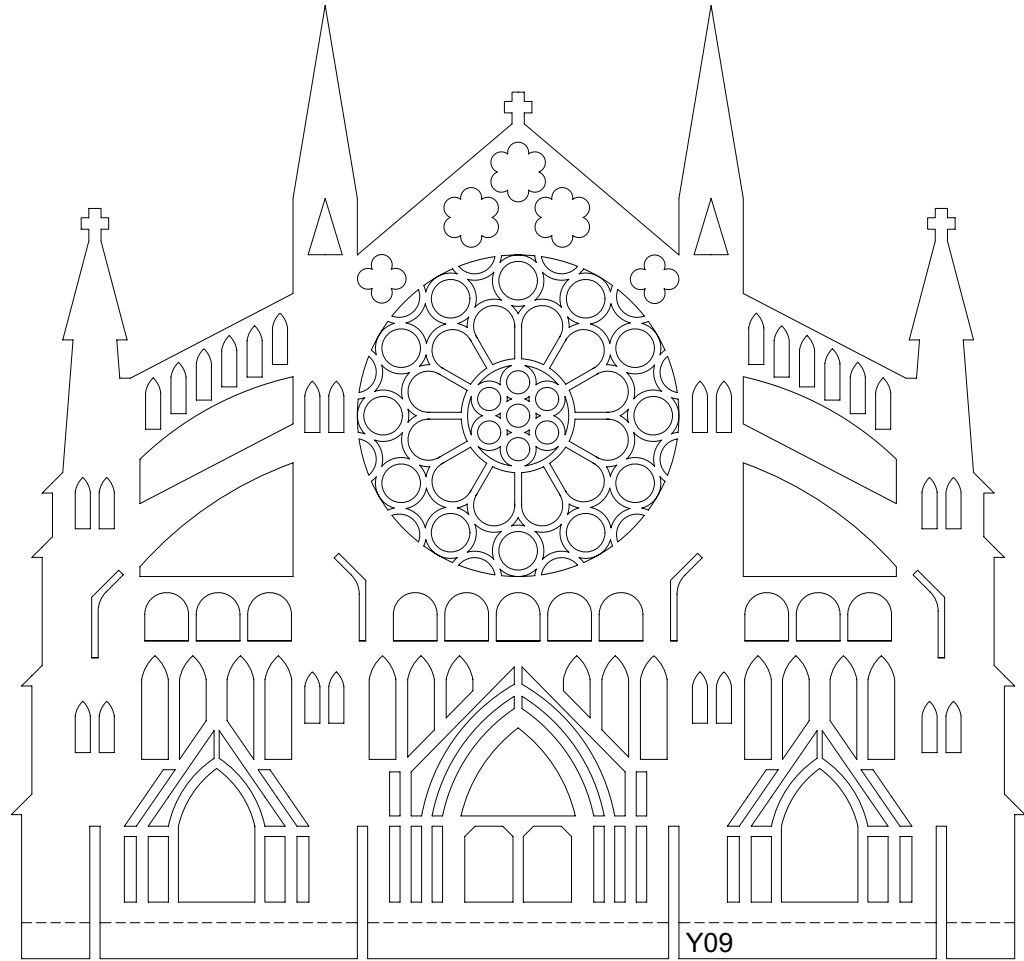
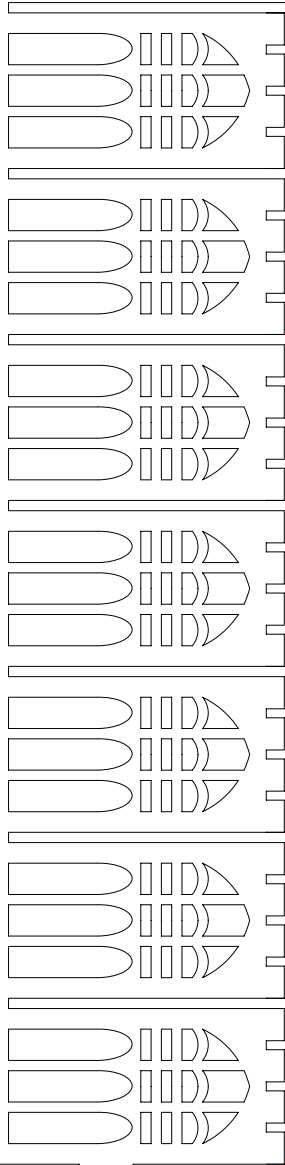
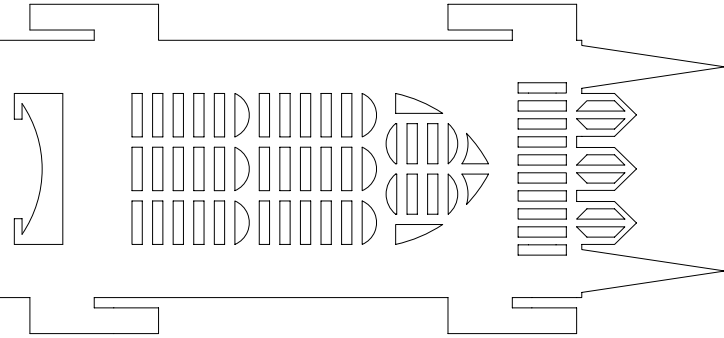

Y09

Print on 60lb to 120lb 8.5" x 11" card stock. Scaling 100%.
Do not use your "fit to paper" option on your printer.

Y03

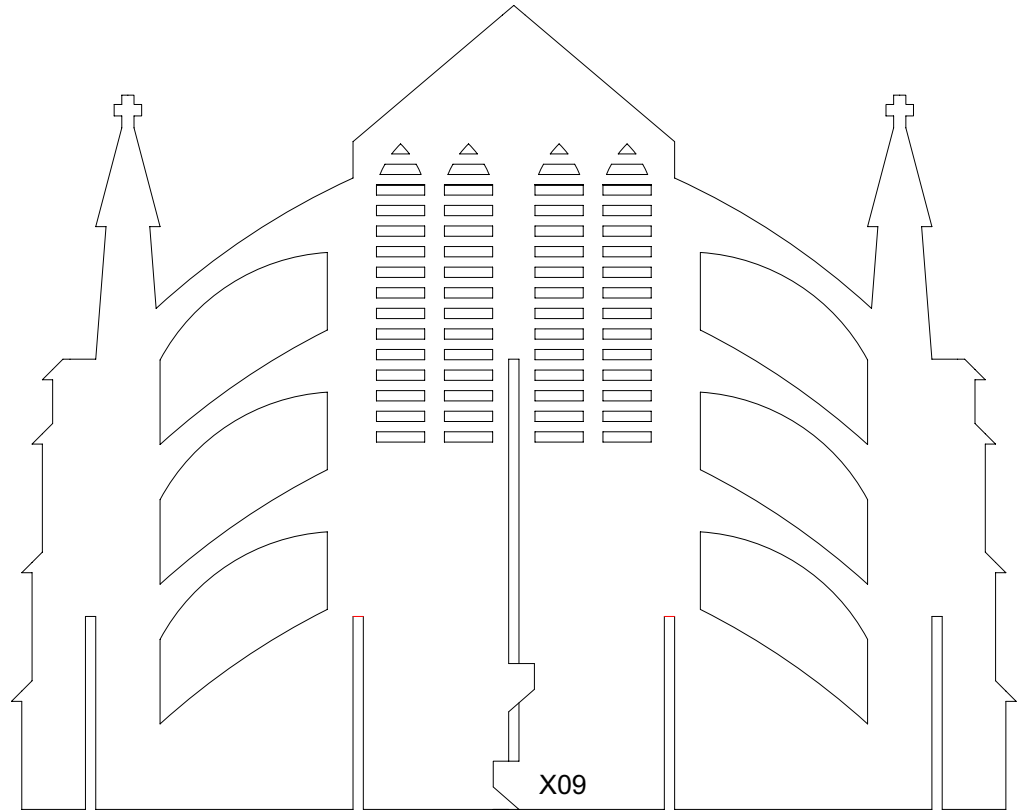
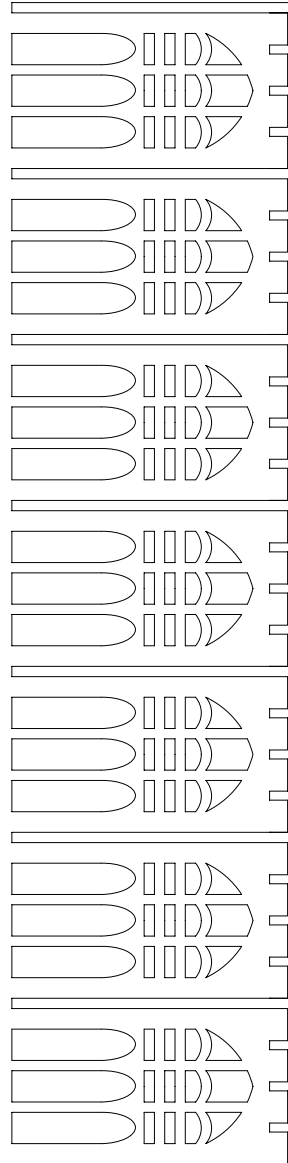
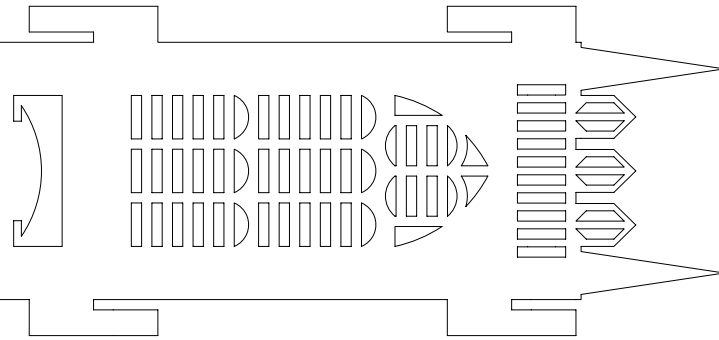

Print on 60lb to 120lb 8.5" x 11" card stock. Scaling 100%.
Do not use your "fit to paper" option on your printer.

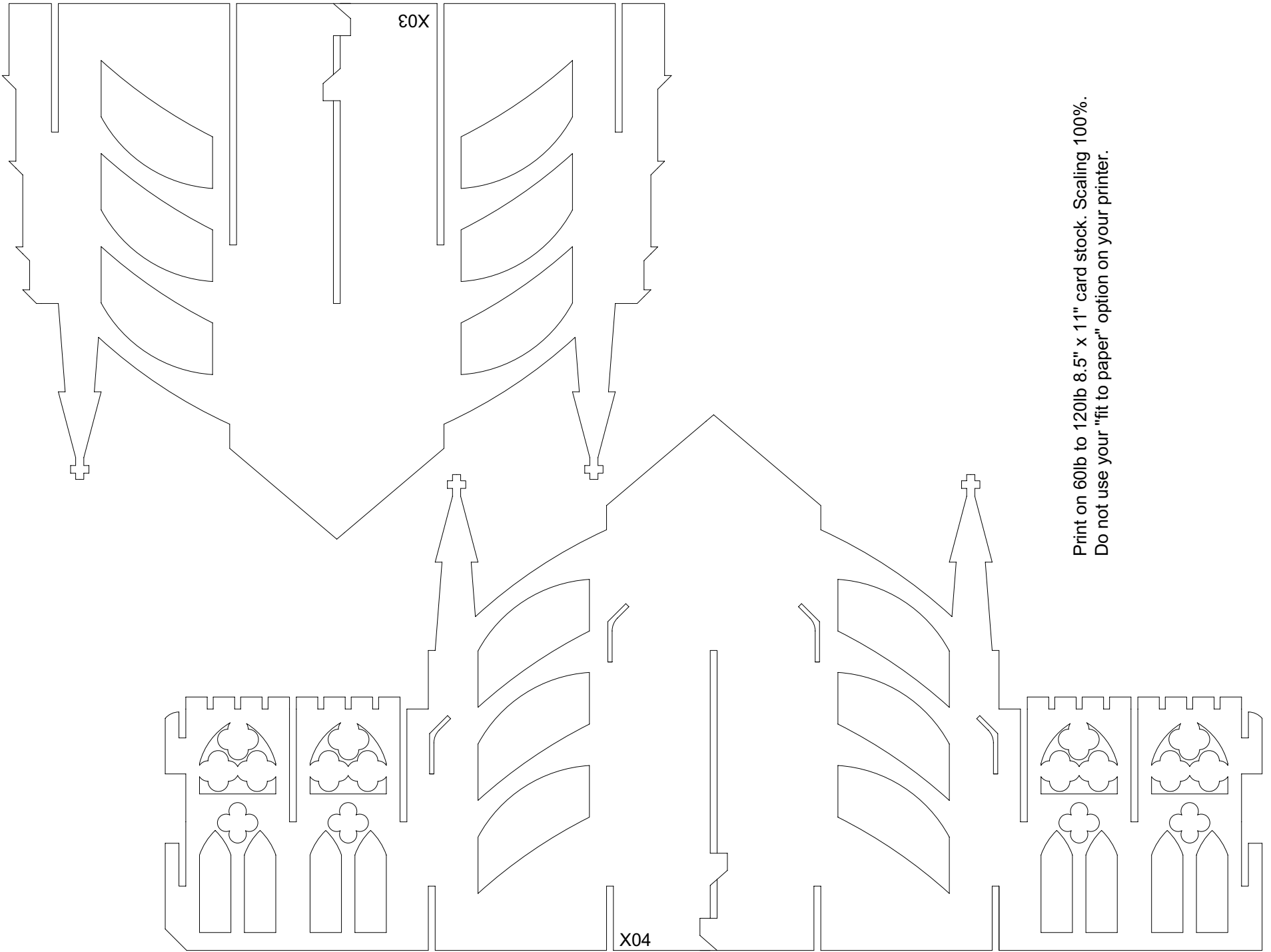

Print on 60lb to 120lb 8.5" x 11" card stock. Scaling 100%.
Do not use your "fit to paper" option on your printer.

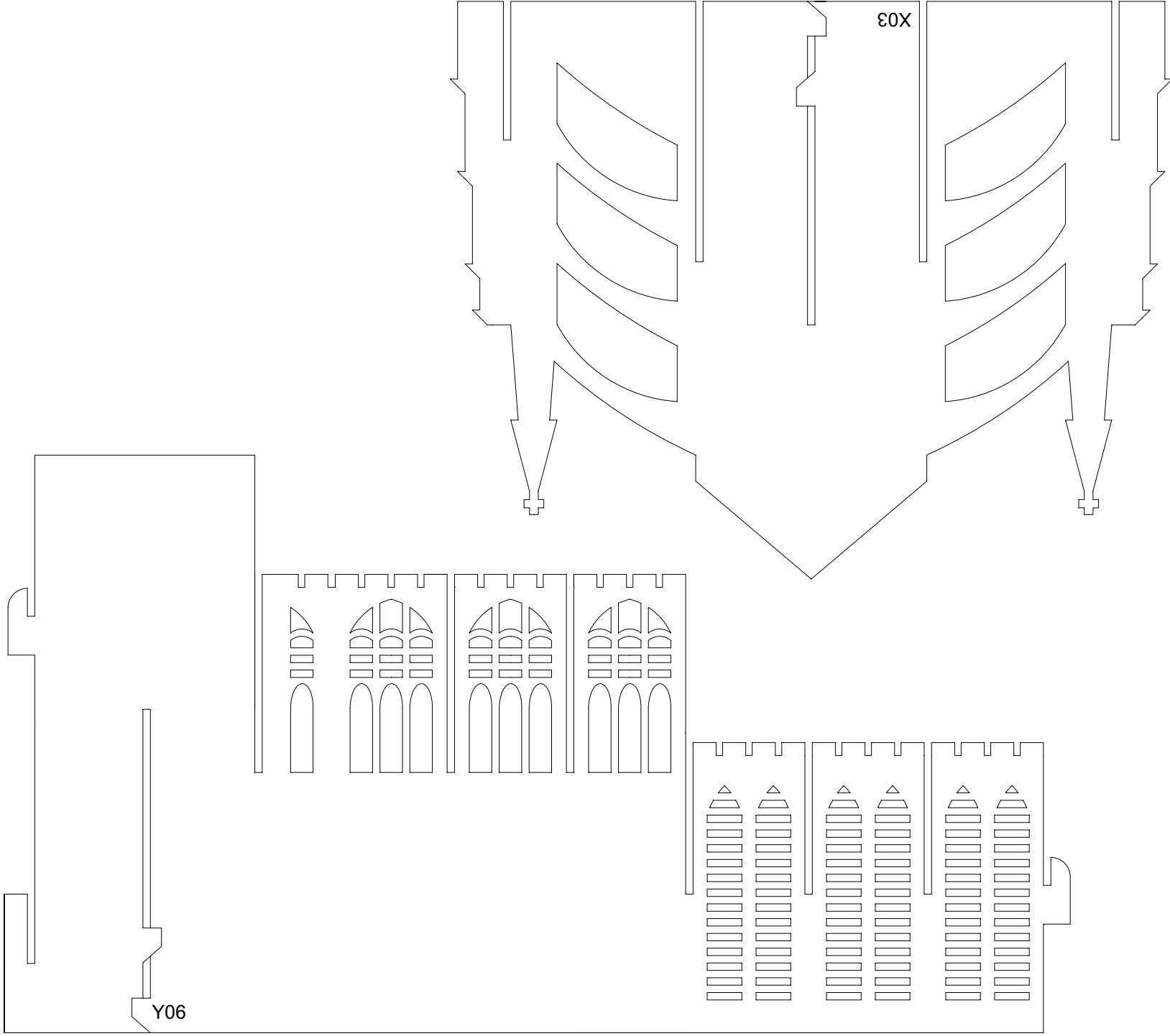

Print on 60lb to 120lb 8.5" x 11" card stock. Scaling 100%. Do not use your "fit to paper" option on your printer.

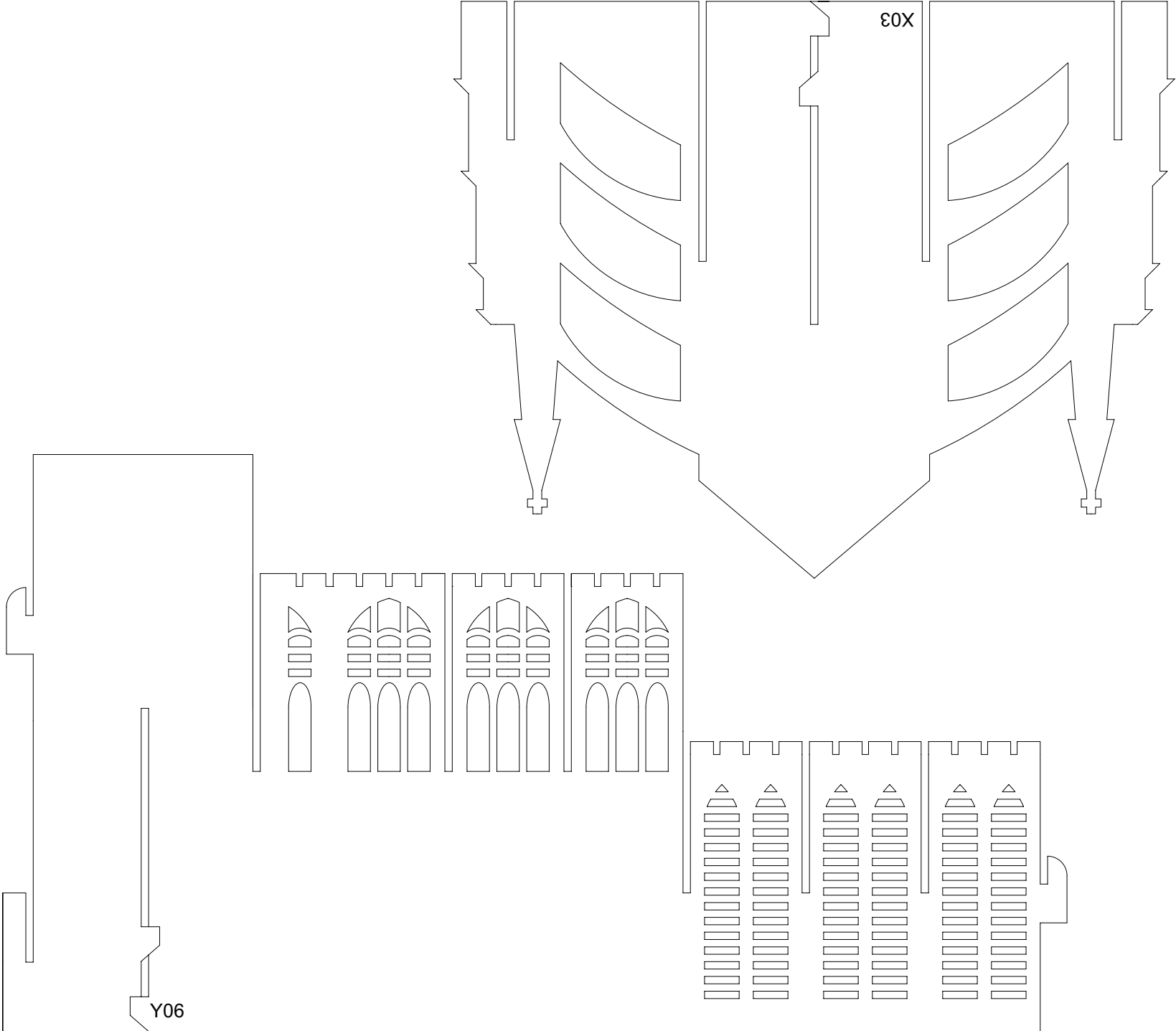

Print on 60lb to 120lb 8.5" x 11" card stock. Scaling 100%. Do not use your "fit to paper" option on your printer.

Print on 60lb to 120lb 8.5" x 11" card stock. Scaling 100%. Do not use your "fit to paper" option on your printer.

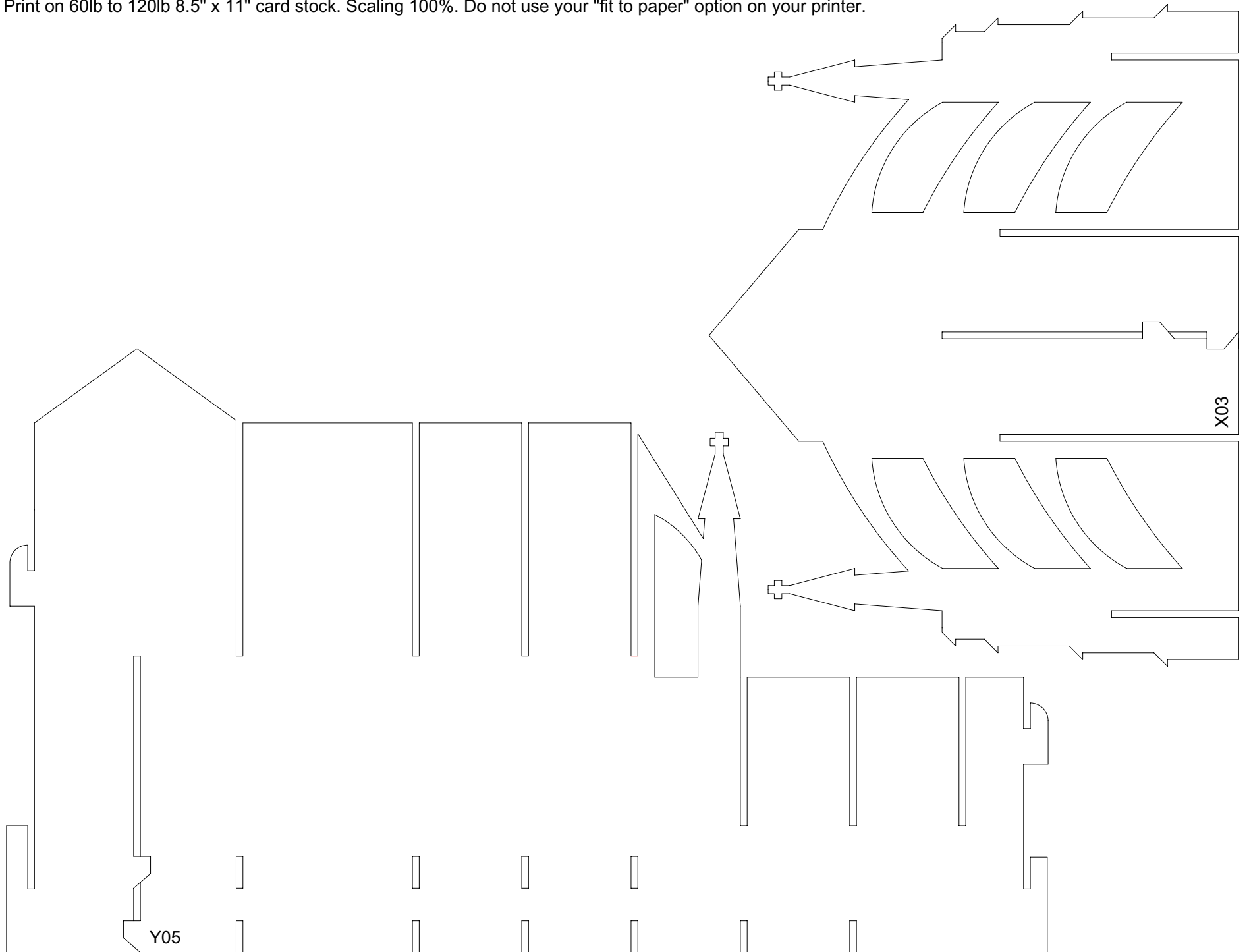

Print on 60lb to 120lb 8.5" x 11" card stock. Scaling 100%.
Do not use your "fit to paper" option on your printer.

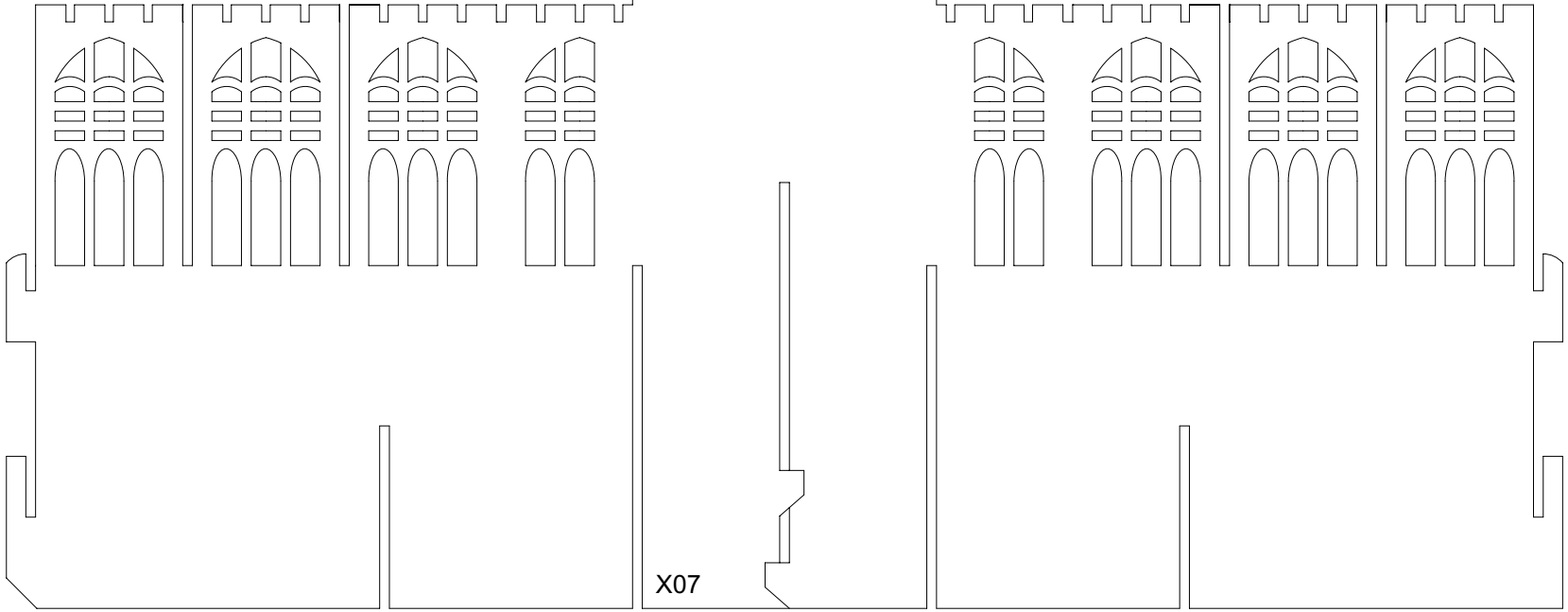
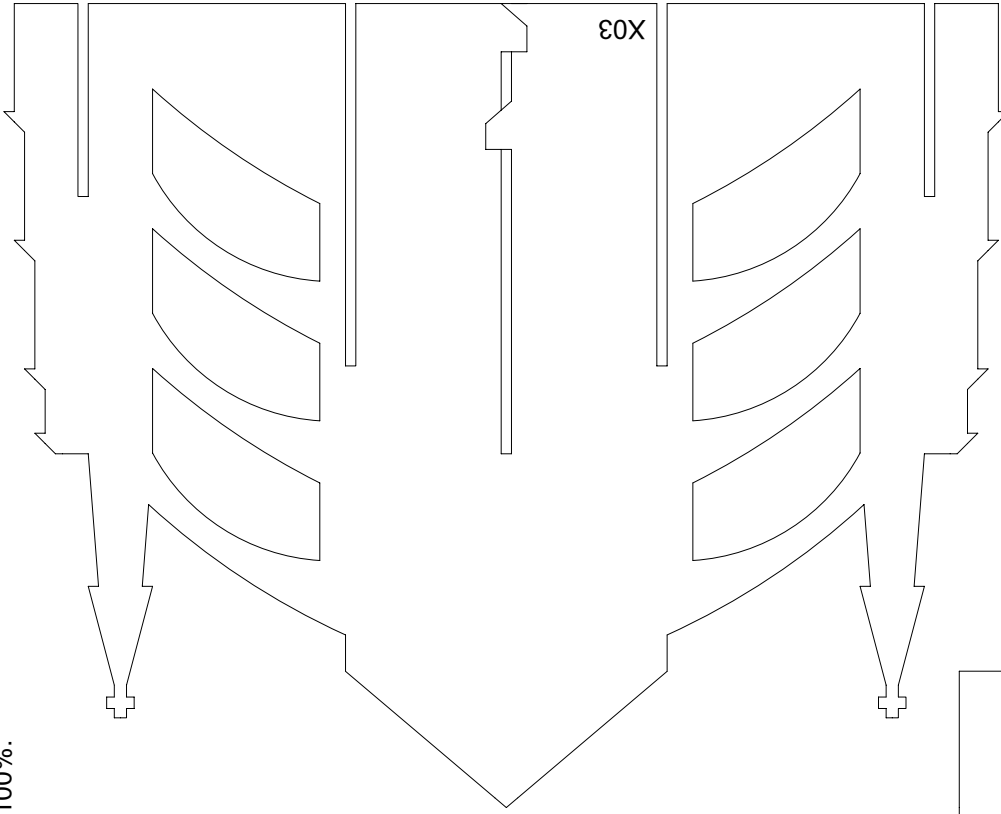

Print on 60lb to 120lb 8.5" x 11" card stock. Scaling 100%.
Do not use your "fit to paper" option on your printer.

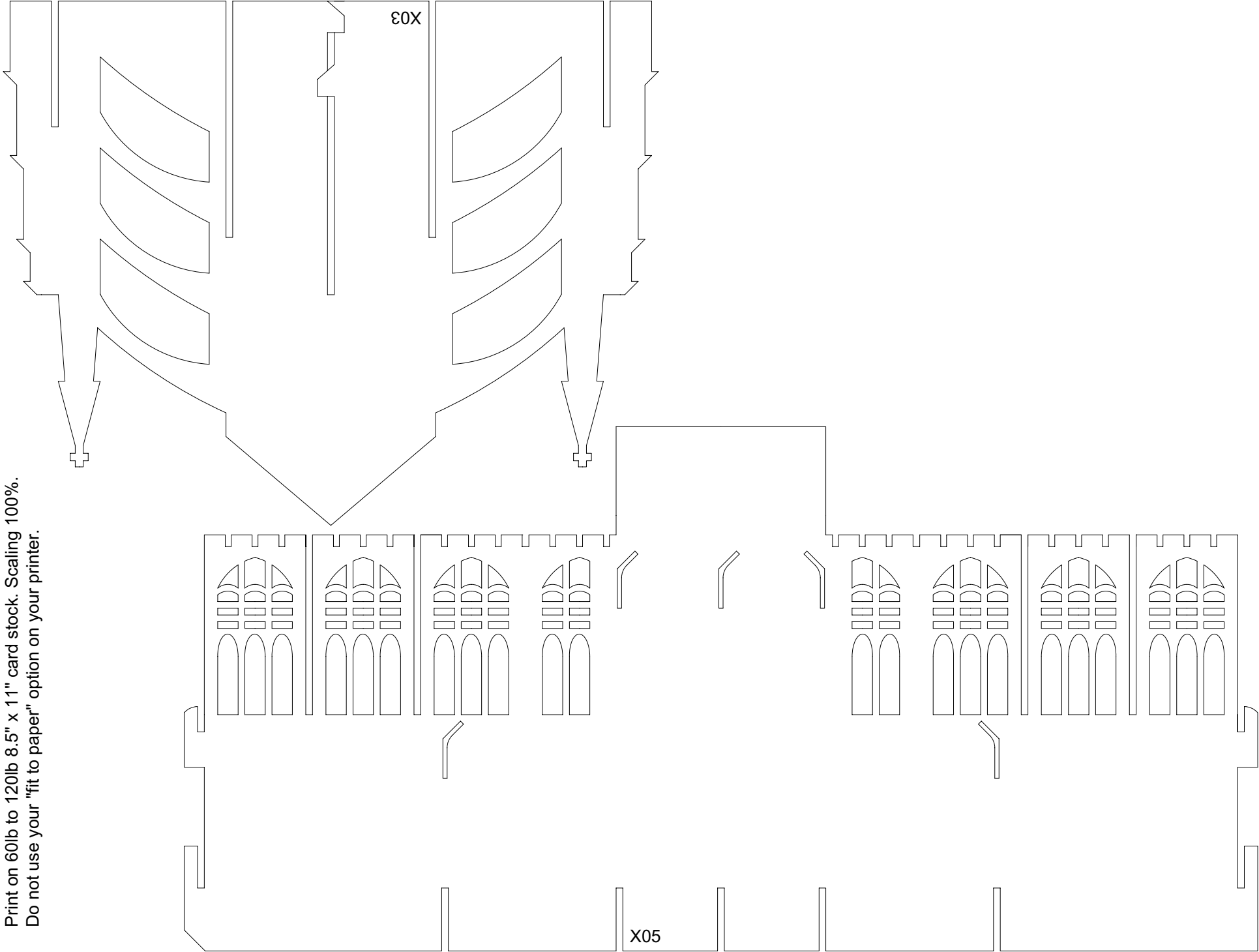

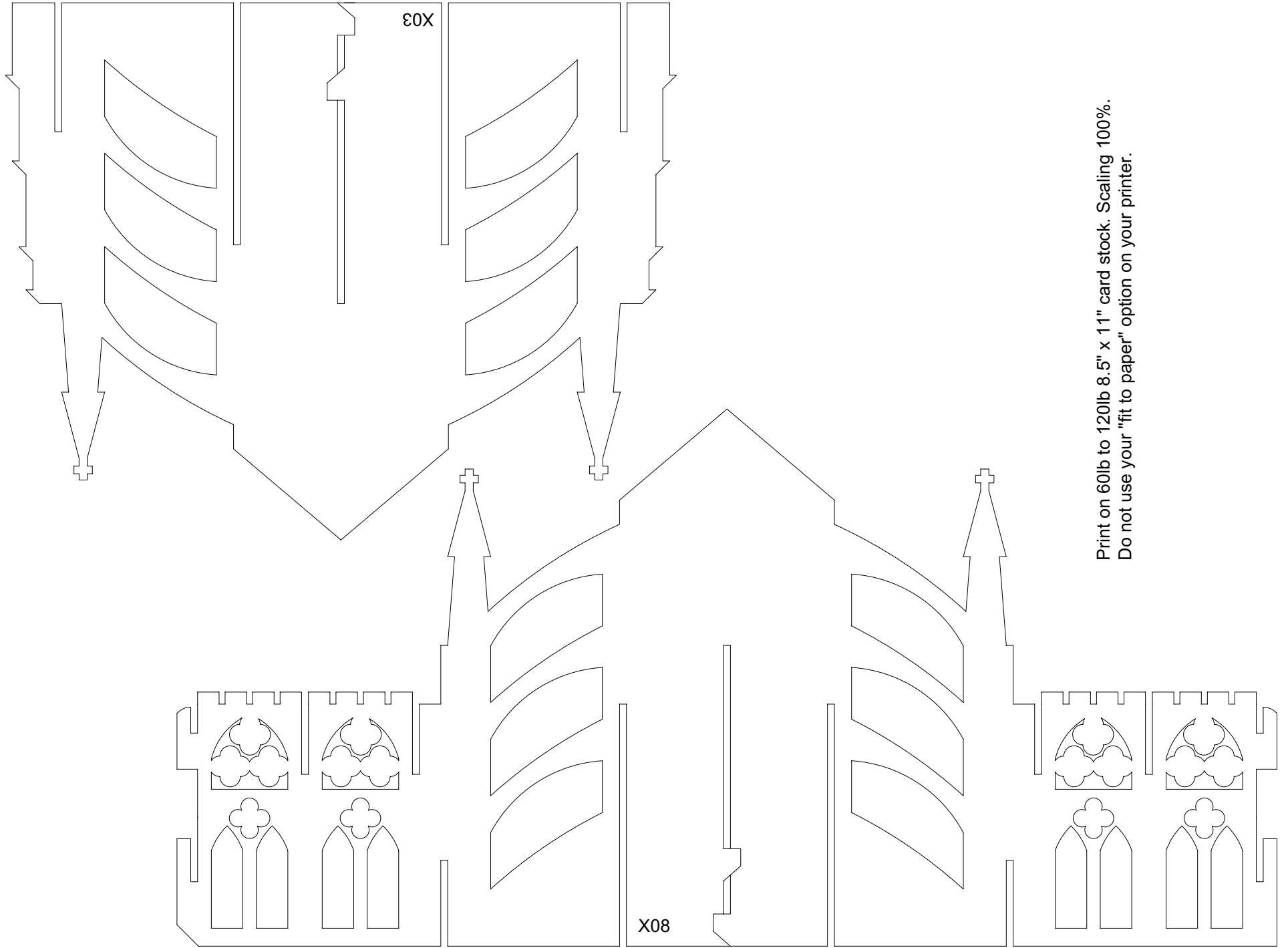

Print on 60lb to 120lb 8.5" x 11" card stock. Scaling 100%.
Do not use your "fit to paper" option on your printer.

Print on 60lb to 120lb 8.5" x 11" card stock. Scaling 100%. Do not use your "fit to paper" option on your printer.

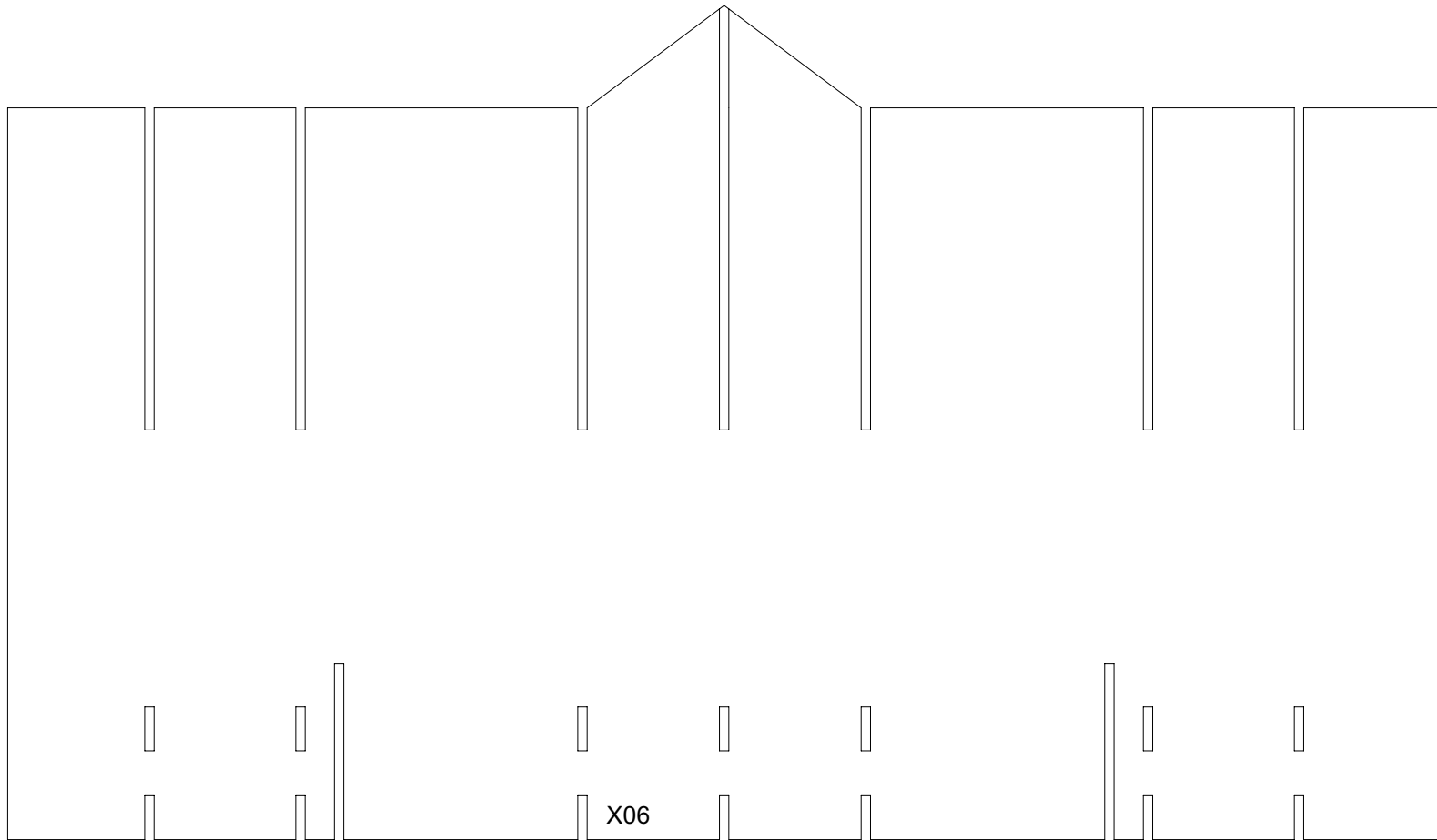

Print on 60lb to 120lb 8.5" x 11" card stock. Scaling 100%. Do not use your "fit to paper" option on your printer.

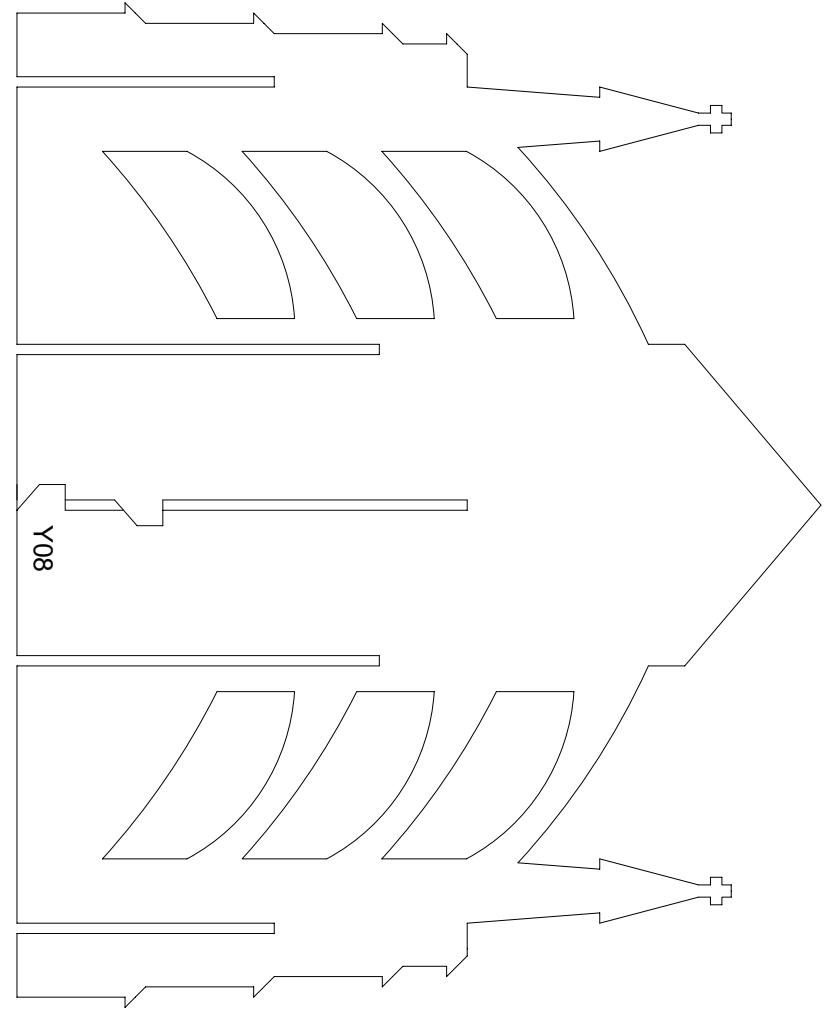
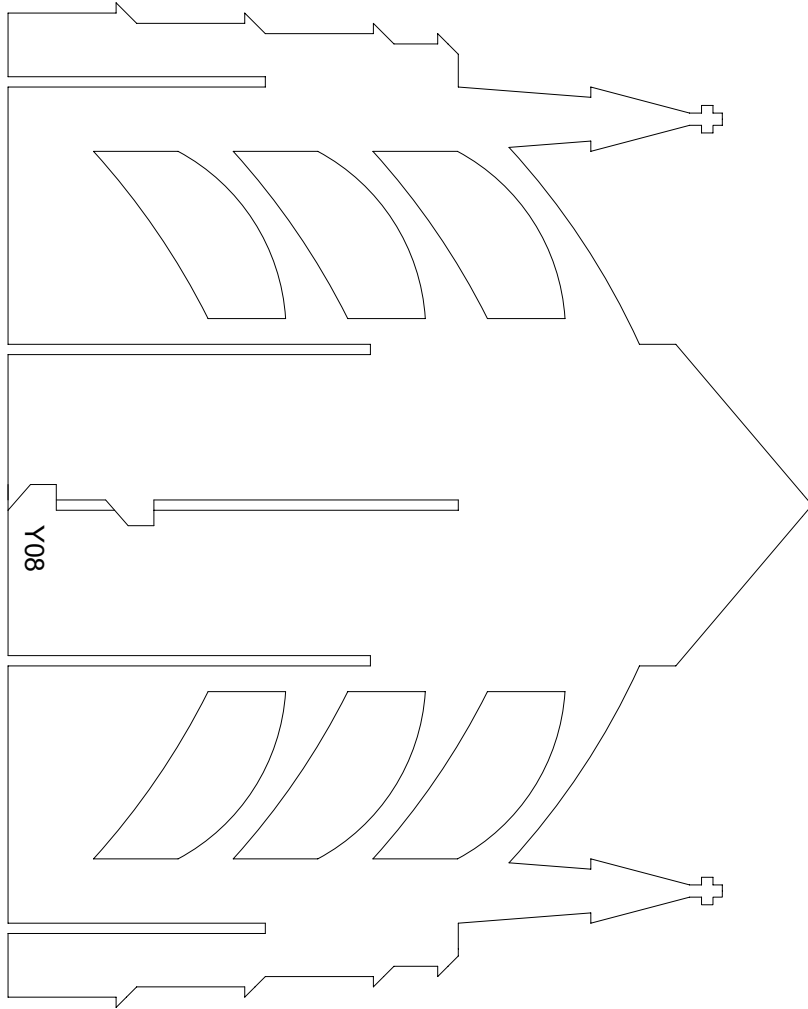

Print on 60lb to 120lb 8.5" x 11" card stock. Scaling 100%. Do not use your "fit to paper" option on your printer.

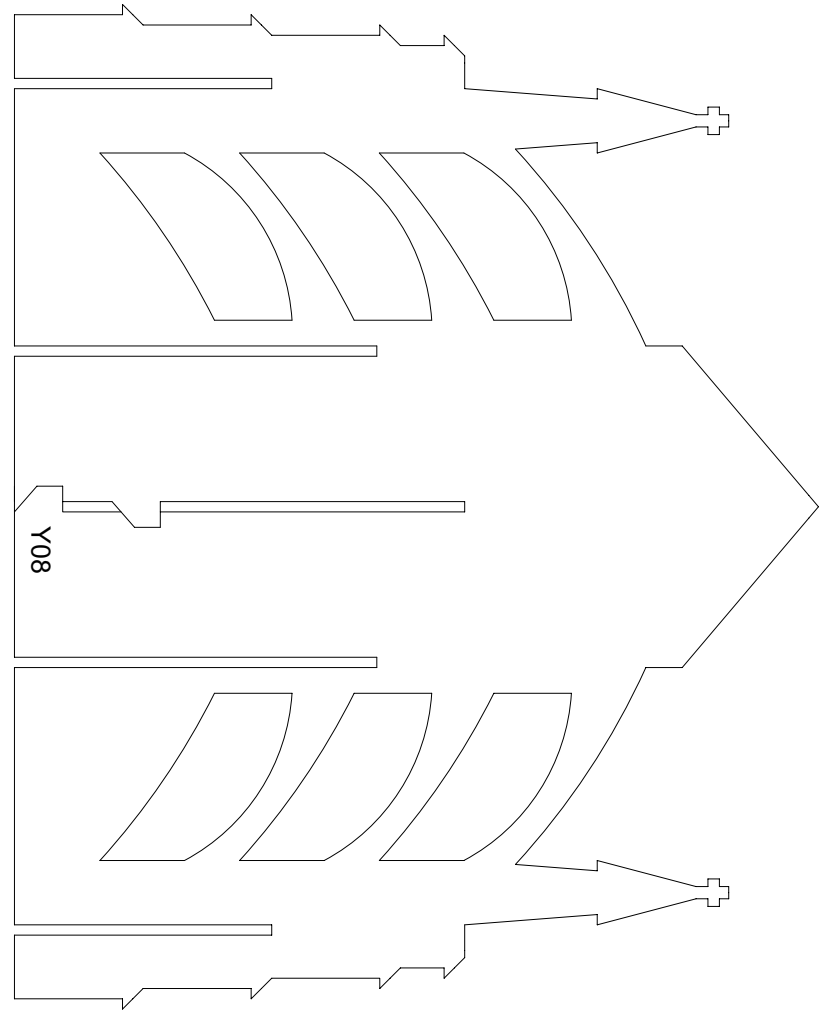
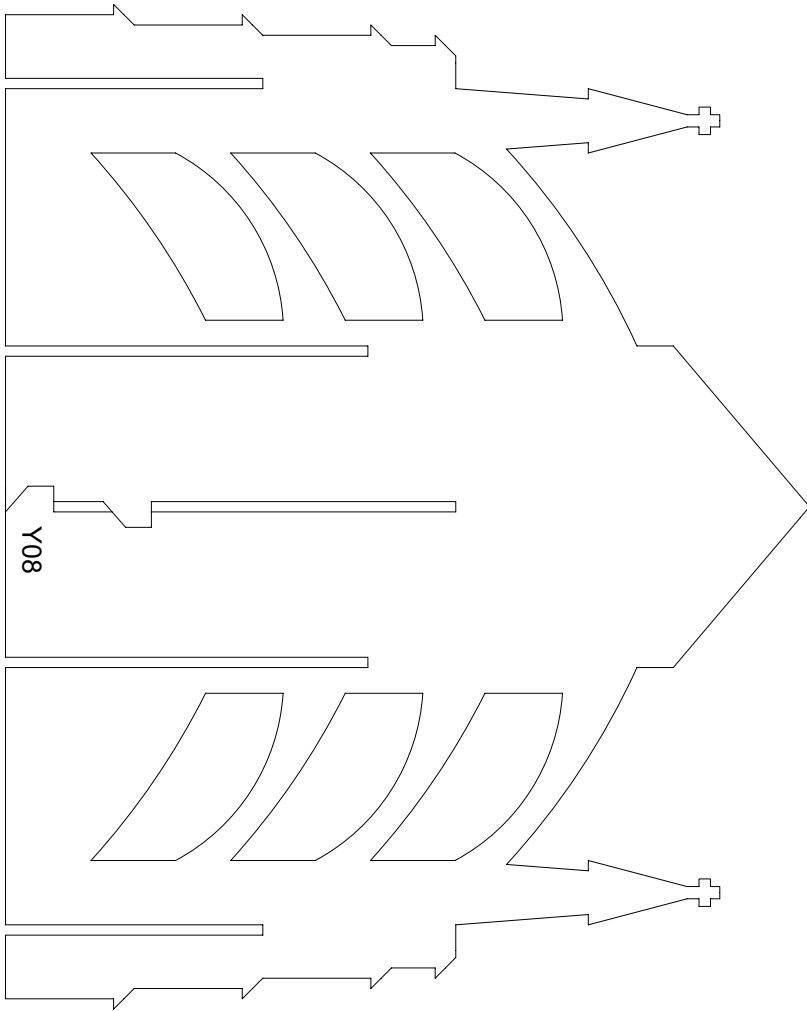

Don't print this page.

Cut 16.5" x 12" and 16.5" x 6" stiff cardboards.
Glue a paper strip to joint them.
Then, use pencil to draw a 45° line as shown in the figure.

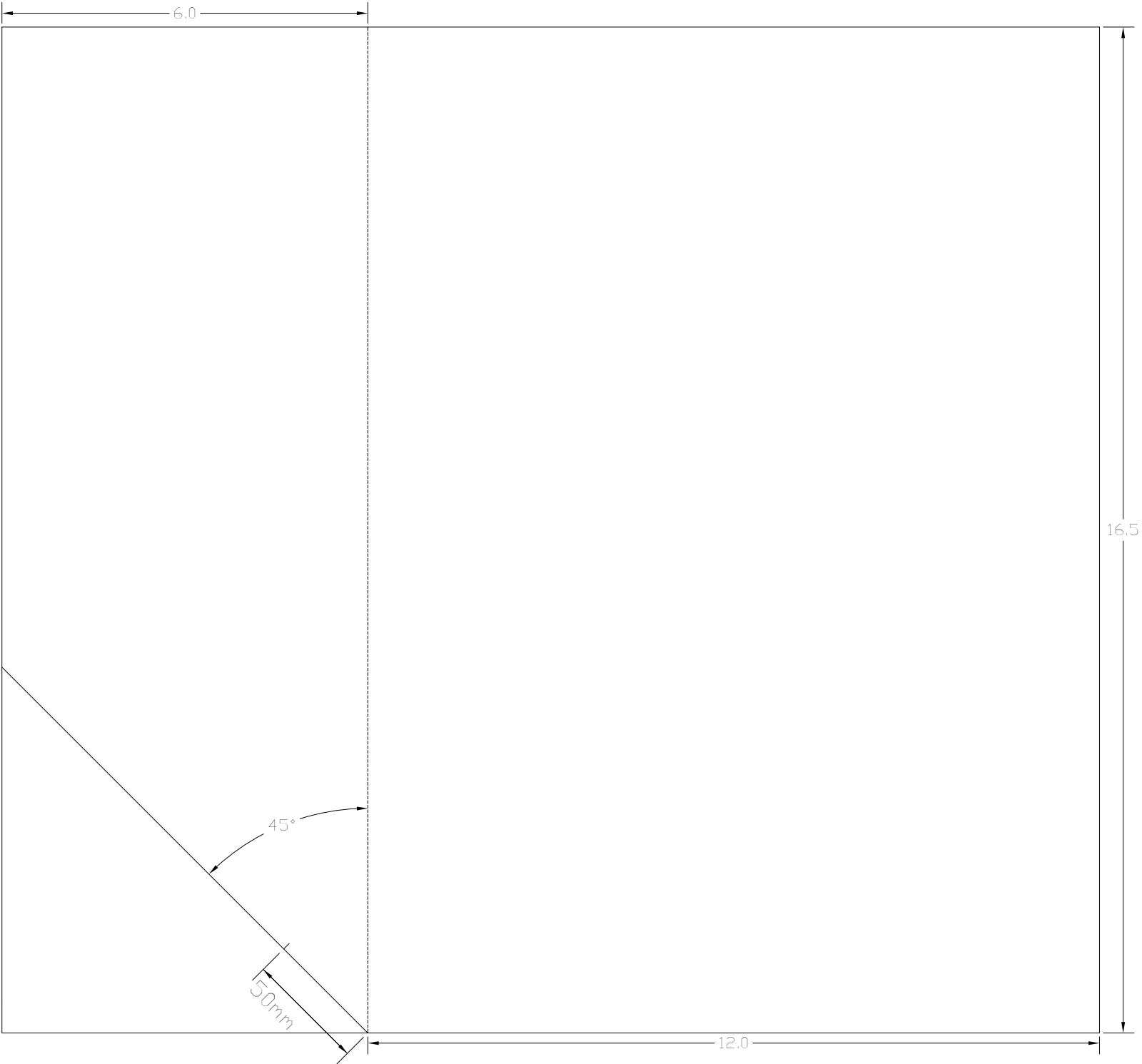

Unit: inch