

Print on 60lb to 120lb 8.5" x 11" card stock. Scaling 100%. Do not use your "fit to paper" option on your printer.

X04

X04

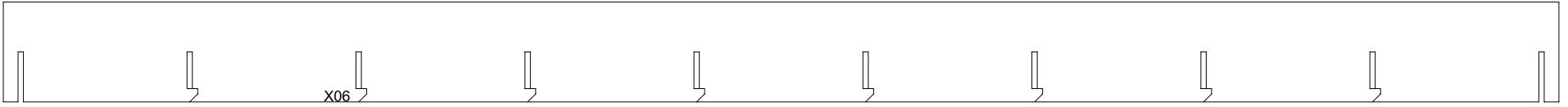

Print on 60lb to 120lb 8.5" x 11" card stock. Scaling 100%. Do not use your "fit to paper" option on your printer.

X04

X04

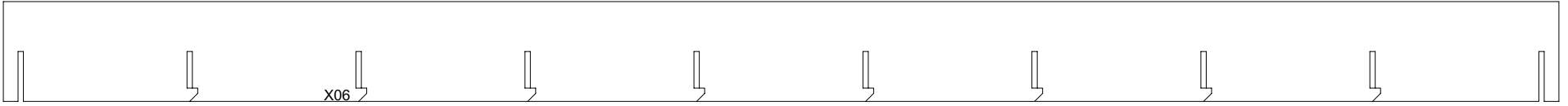

Print on 60lb to 120lb 8.5" x 11" card stock. Scaling 100%. Do not use your "fit to paper" option on your printer.

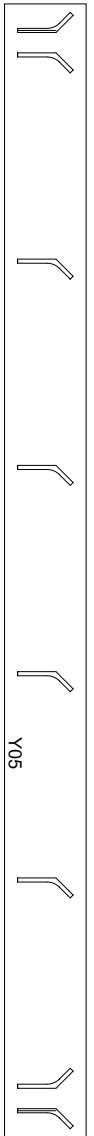
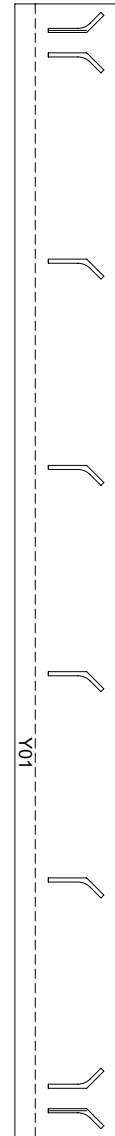
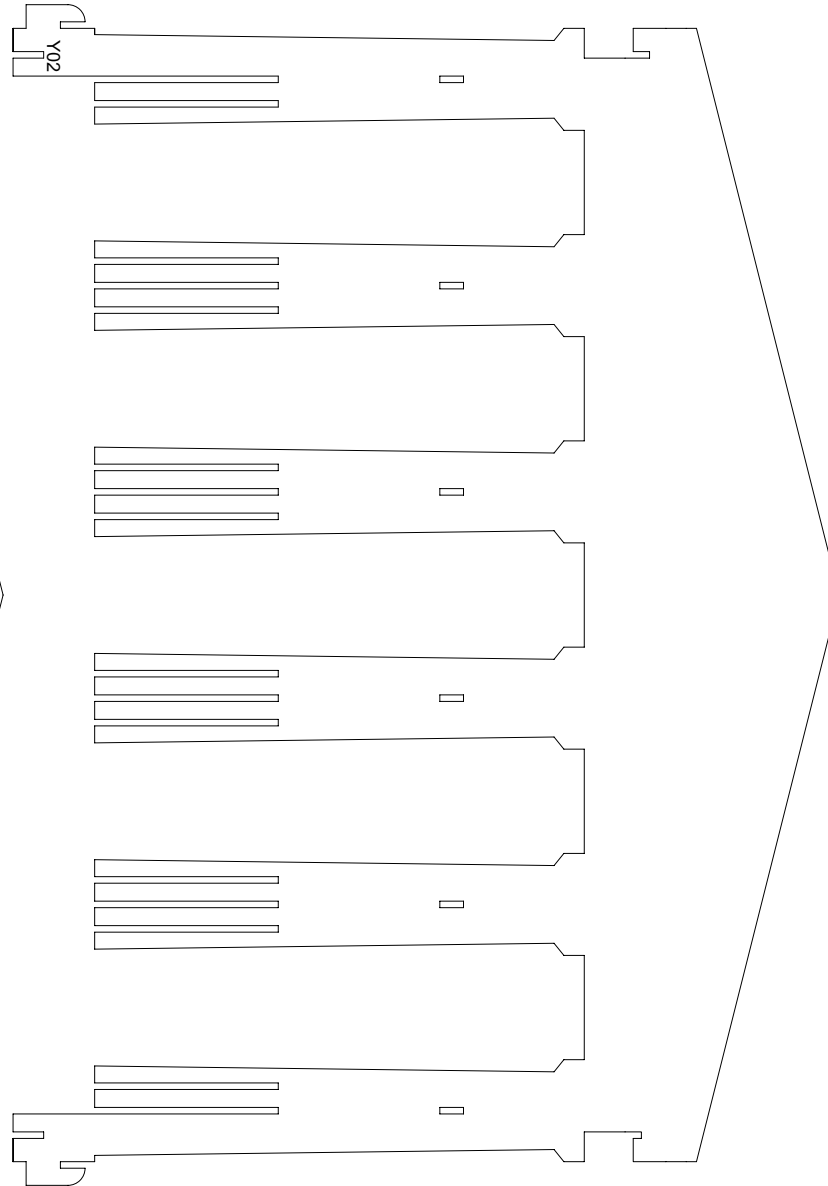
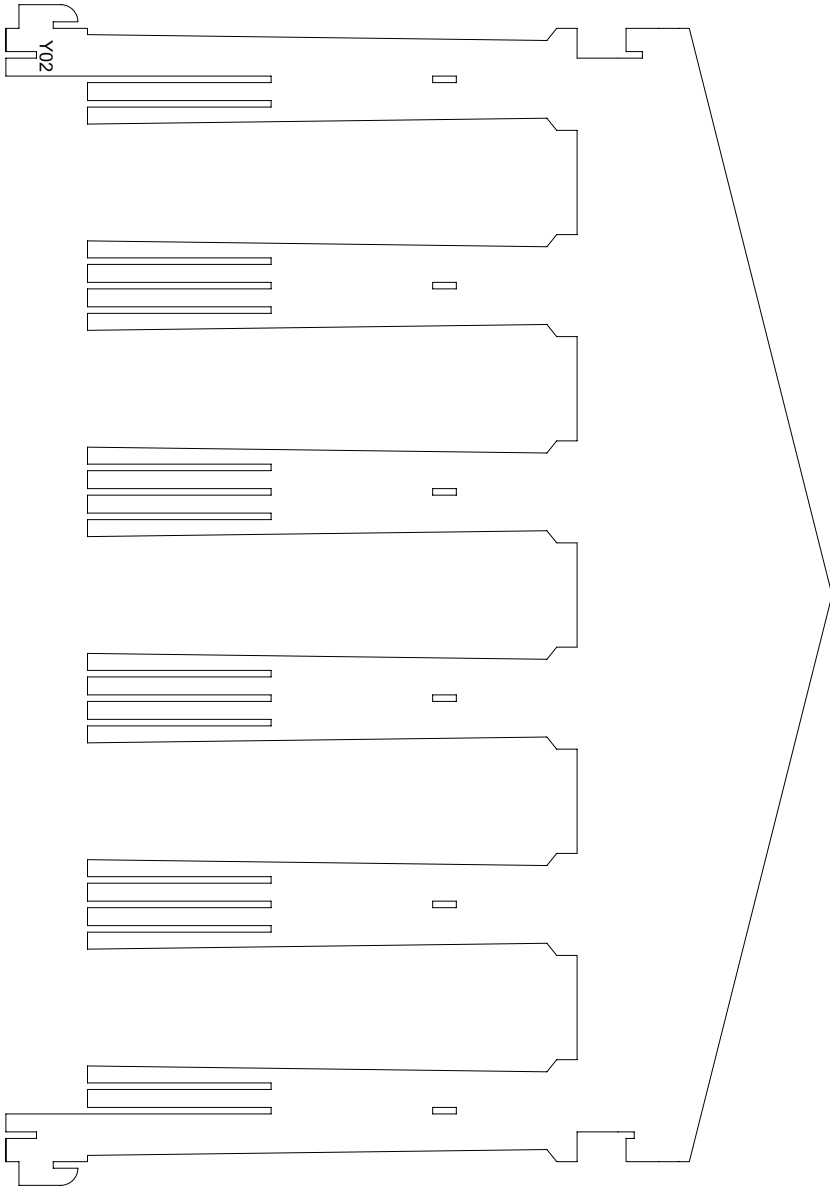

Print on 60lb to 120lb 8.5" x 11" card stock. Scaling 100%. Do not use your "fit to paper" option on your printer.

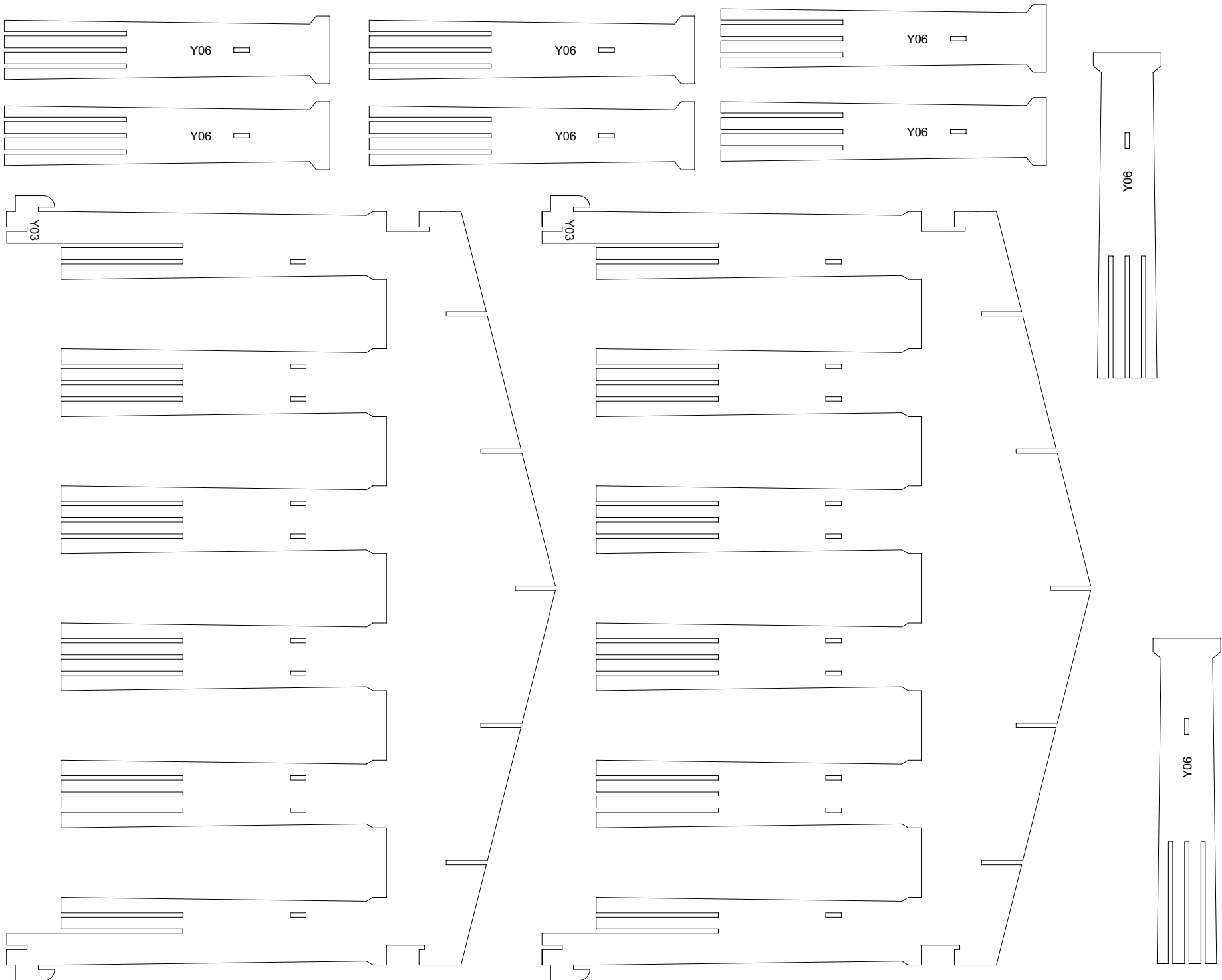

Print on 60lb to 120lb 8.5" x 11" card stock. Scaling 100%. Do not use your "fit to paper" option on your printer.

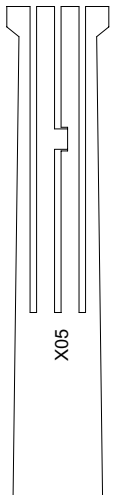
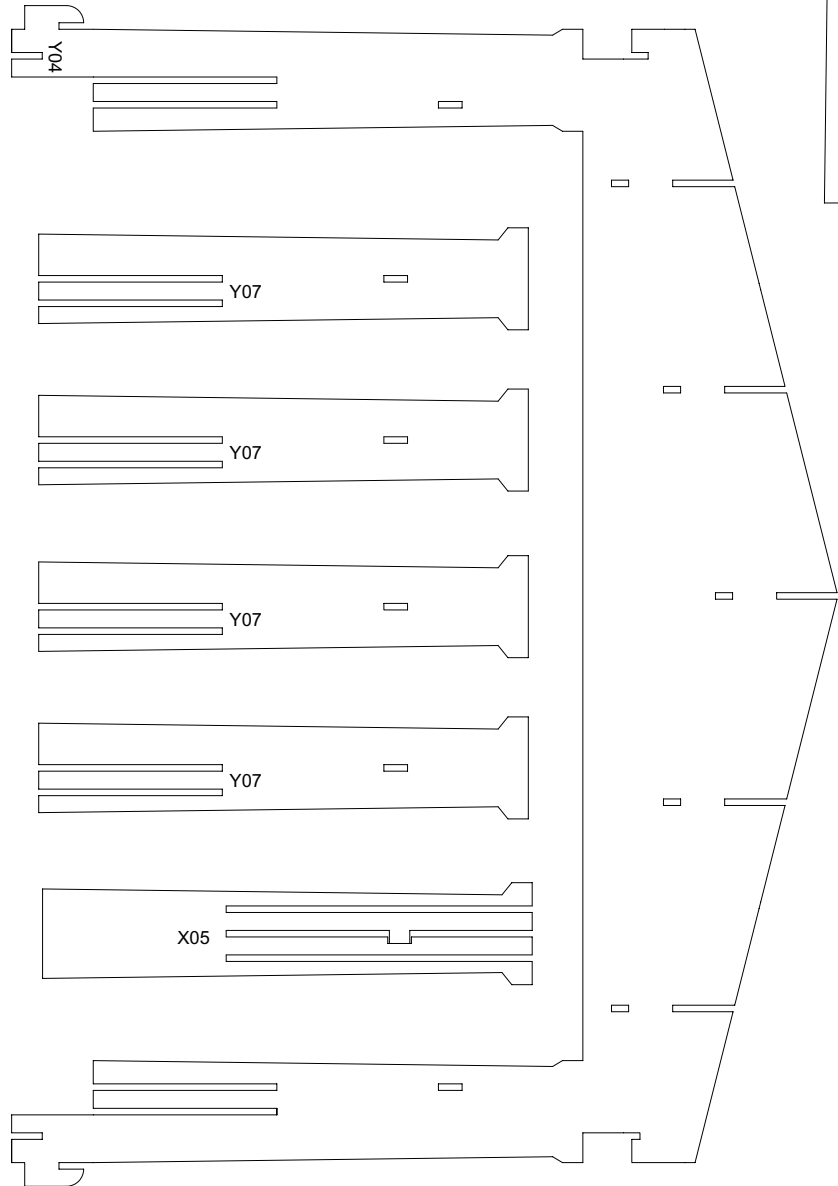
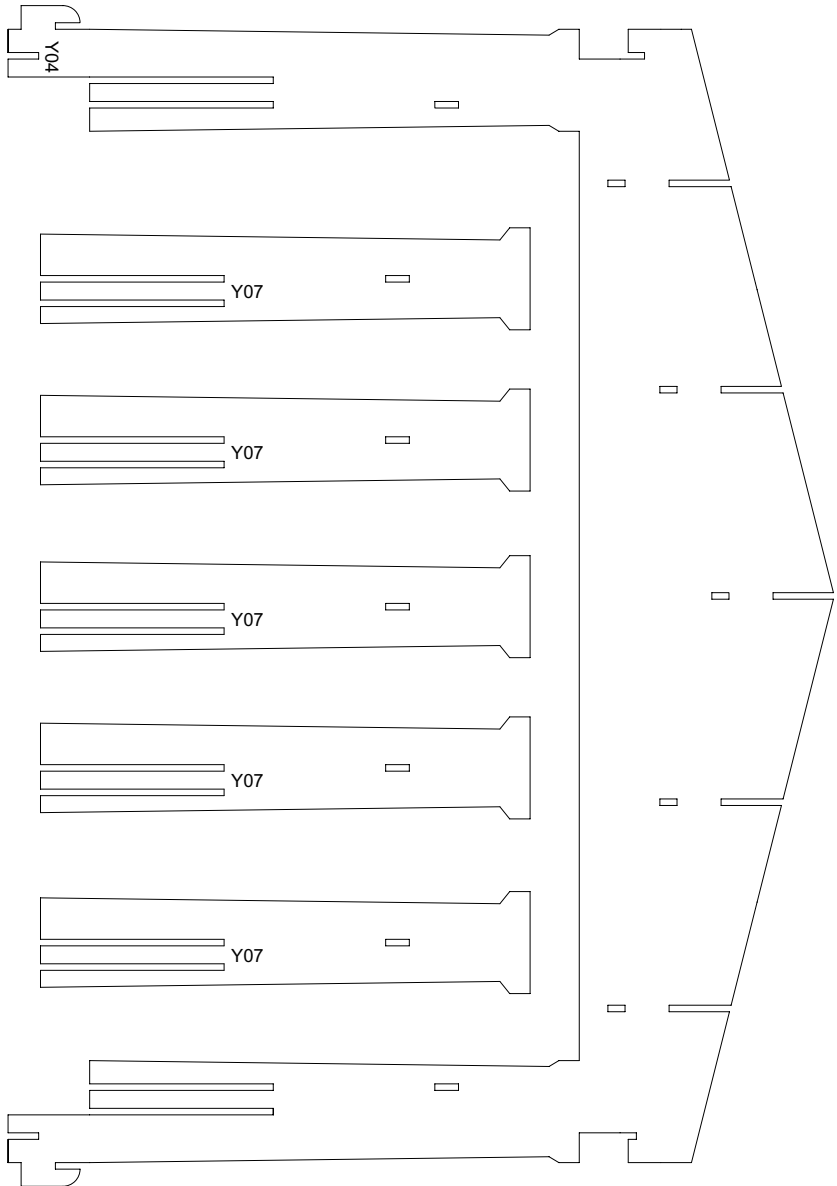
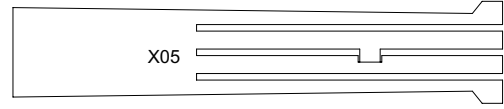
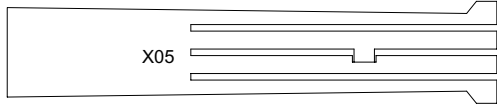
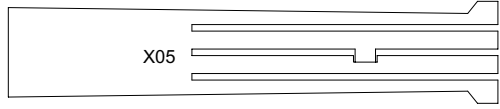
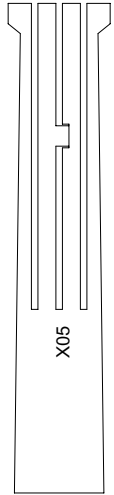
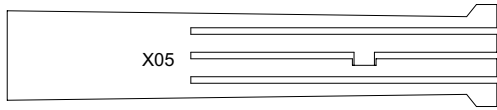
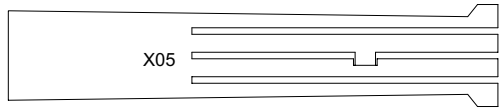

Print on 60lb to 120lb 8.5" x 11" card stock. Scaling 100%. Do not use your "fit to paper" option on your printer.

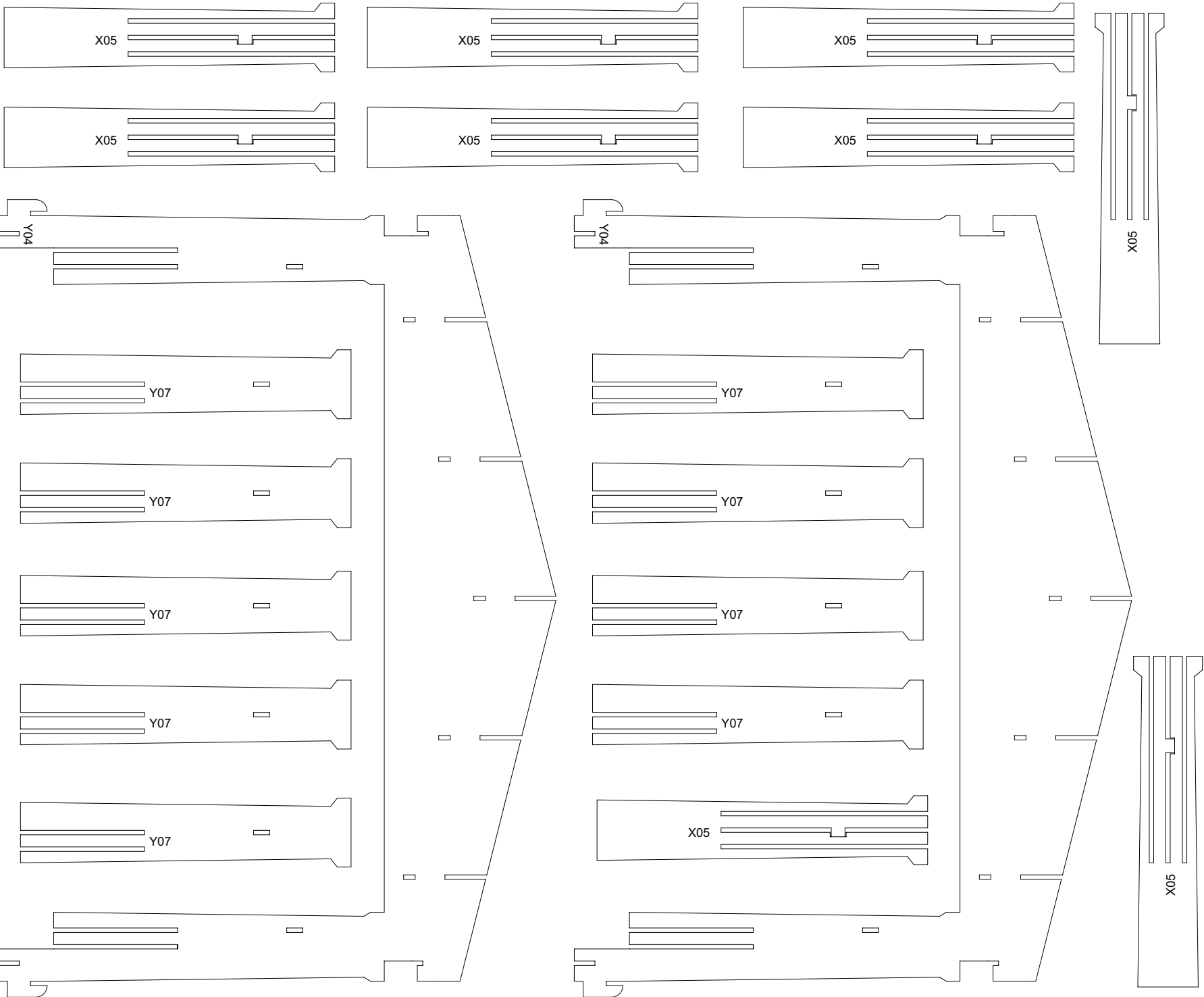

Print on 60lb to 120lb 8.5" x 11" card stock. Scaling 100%. Do not use your "fit to paper" option on your printer.

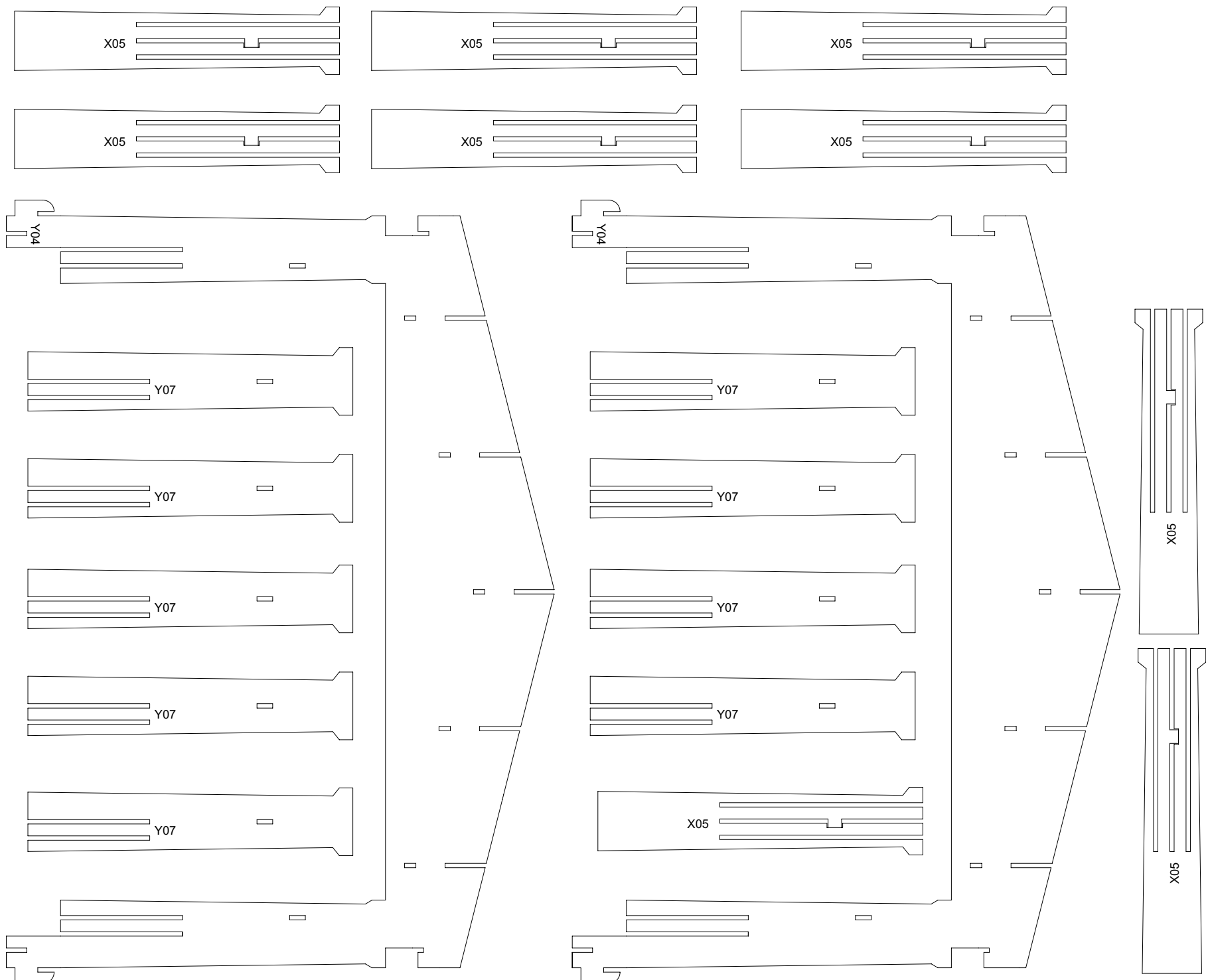

Print on 60lb to 120lb 8.5" x 11" card stock. Scaling 100%. Do not use your "fit to paper" option on your printer.

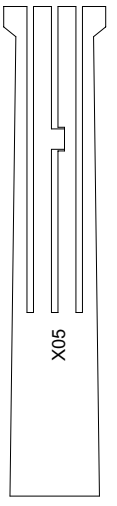
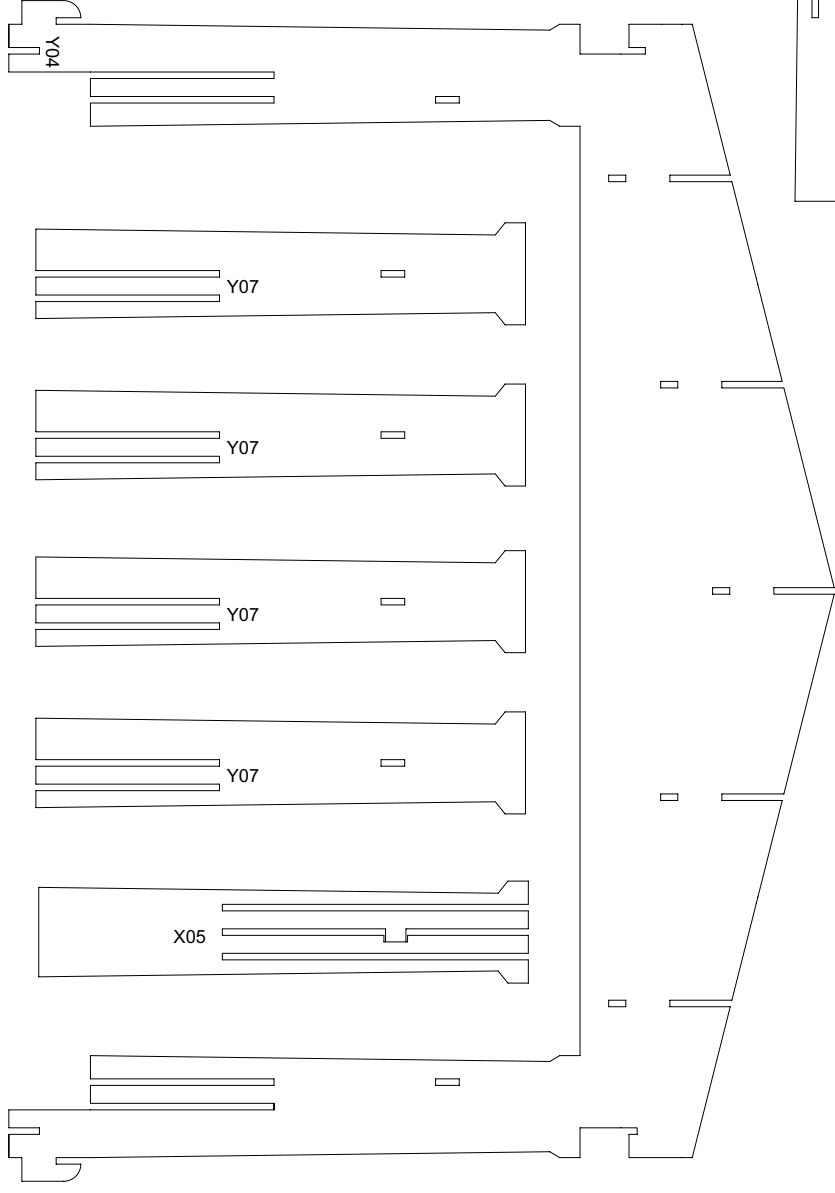
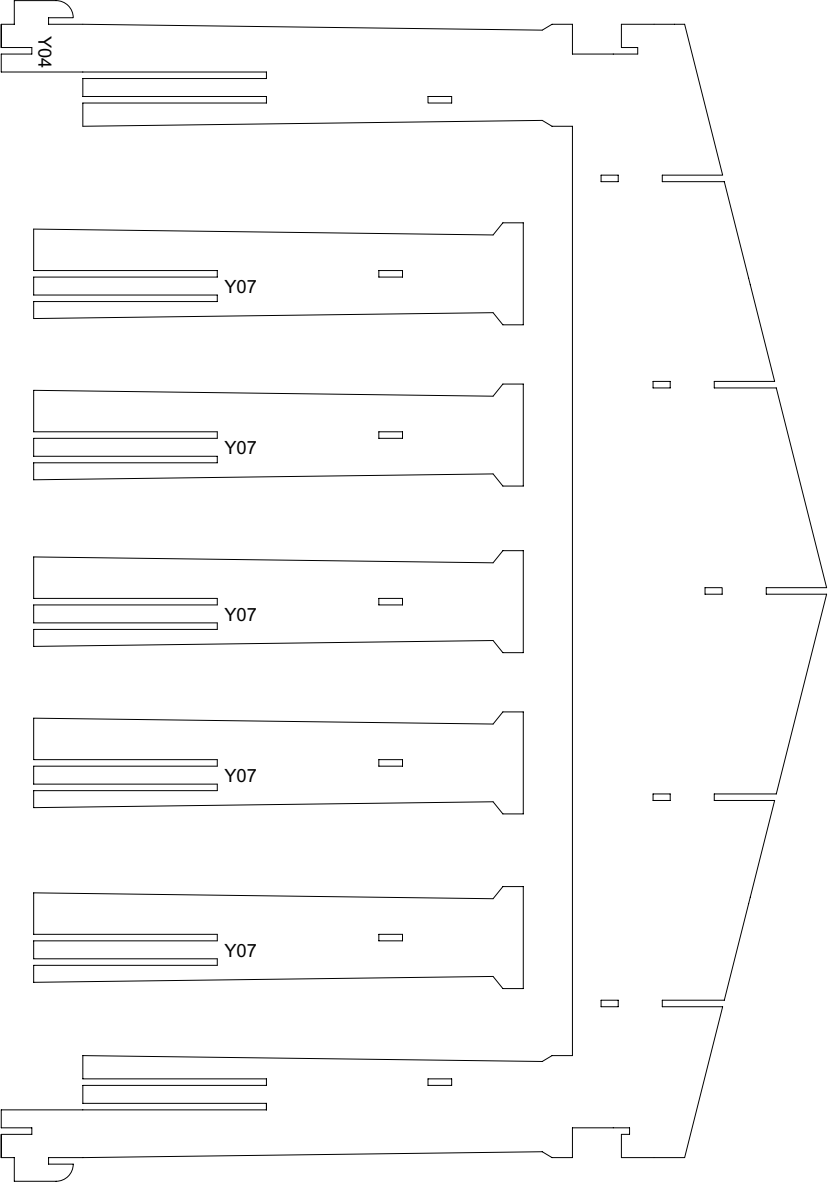
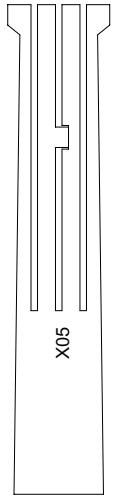
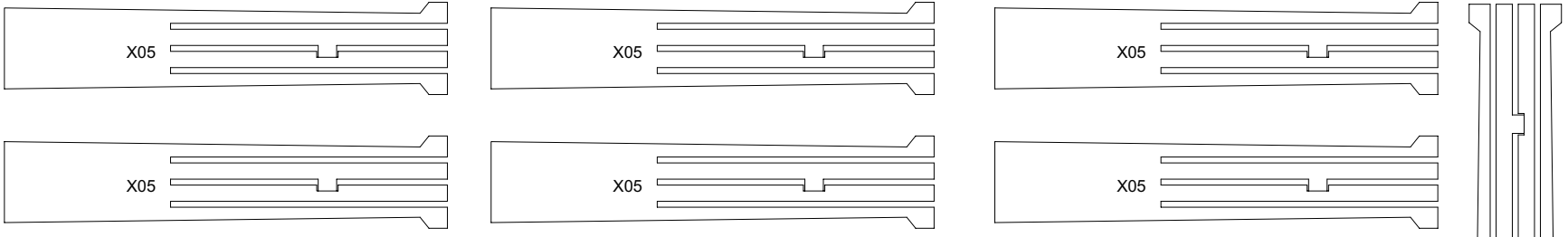

Don't print this page.

Cut 12.5" x 8" and 12.5" x 5" stiff cardboards.
Glue a paper strip to joint them.
Then, use pencil to draw a 45° line as shown in the figure.

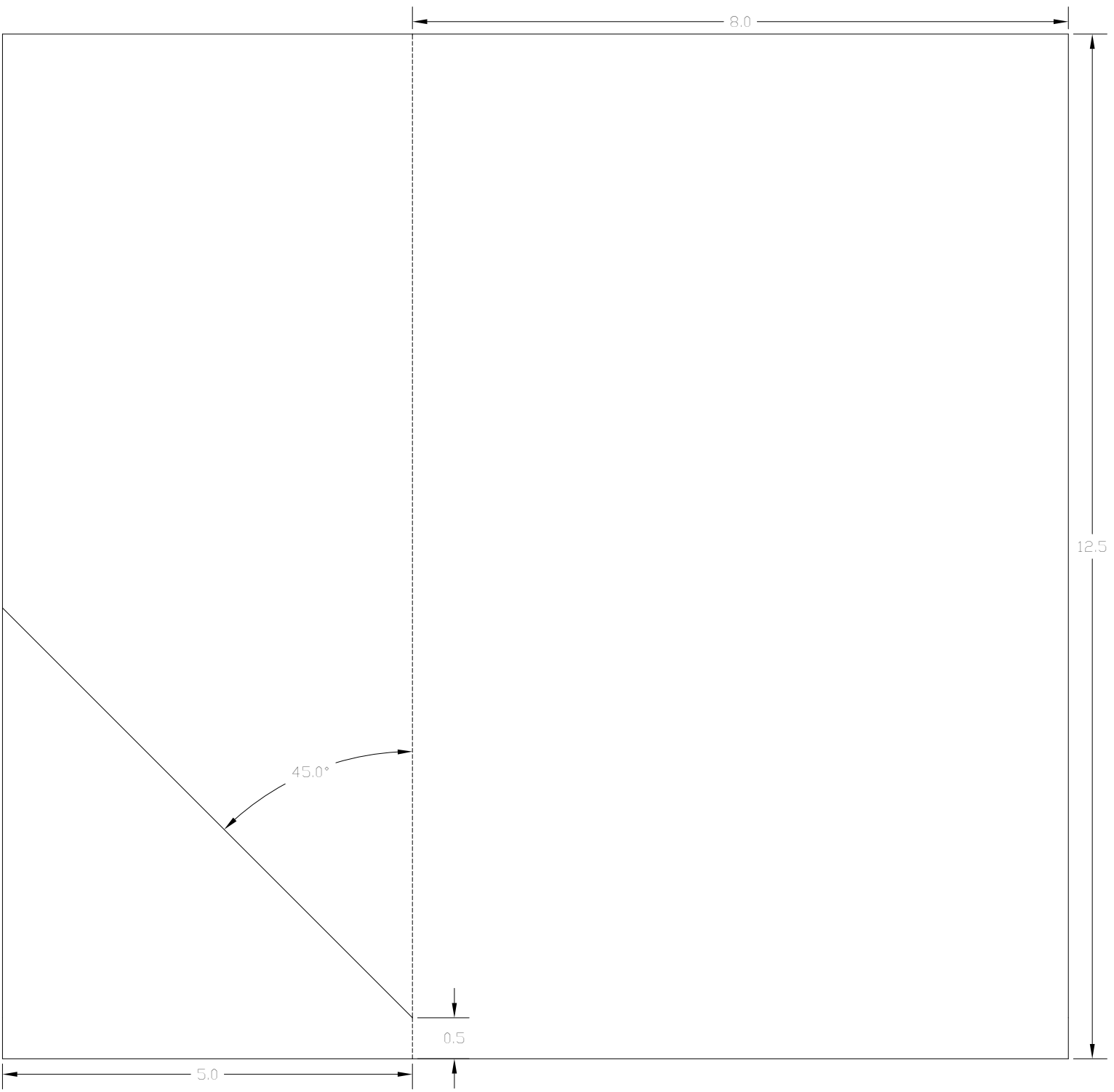

Unit: inch